



SURGE ACTUATORS

HYDRAULIC SURGE BRAKE ACTUATION

INSTALLATION INSTRUCTIONS

DX20 Actuator (Formerly “Raptor” Model 20) for Trailer Brakes 20,000 lbs Capacity

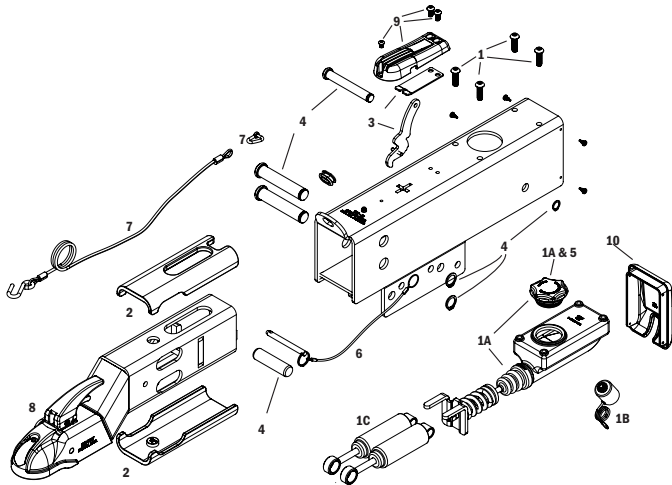

READ AND UNDERSTAND THE ENTIRE INSTRUCTION/ASSEMBLY PROCEDURE BEFORE INSTALLATION.

The DX20 works by the “surge” or “push” of the trailer toward the tow vehicle. This automatically synchronizes the trailer brakes with the brakes on the tow vehicle. When the trailer pushes against the tow vehicle, the actuator telescopes together and applies the force to the master cylinder, supplying hydraulic pressure to the brakes. The built in sealed and independent dampening shock absorber controls the telescoping shock against the hitch.

Be sure to comply with regulations for brakes in your state. Brake laws sometimes are minimum standards and you may wish to add additional brakes to your trailer to meet minimum Gross Vehicle Weight Ratings (G.V.W.R.). Note: G.V.W.R. is the Gross Vehicle Weight Rating which includes the trailer and the load weight as a Total Gross Weight.

READ YOUR TOW VEHICLE OWNER’S MANUAL ON TOWING CAPACITY AND OTHER TOWING RECOMMENDATIONS BEFORE INSTALLATION.

The DX20 Actuator is completely assembled and ready to bolt into place (Tongue sizes: 3”x 4” & 3”x 5”, 9 ga. min.).

1. Bolt the actuator to the tongue-using 5/8” diameter, 4” long grade 5 bolts. Attachment strength should equal or exceed 1-1/2 times trailer G.V.W.R.
2. Hydraulic brake lines should be installed on the trailer as described in the installation manual supplied with the brakes. Note: Some disc brakes require the use of flexible brake lines at the connection point on the brake caliper. Follow brake manufacturer instructions.
3. Use only DOT-3 brake fluid in the DX20 actuator. Use a pressure type brake bleeder to bleed brakes. Follow manufacturer’s directions. Or, manually bleed the brakes using directions on page 3.
4. To bleed master cylinder and brakes, install bleeder hose on first wheel cylinder to be bled; if tandem axle trailer, bleed farthest axle

#	TDE Part #	DX Part #	Description
1A	70403-20K	K68-523-20	Disc Brake DX20 Master Cylinder Kit: master cylinder, cap and 4 mounting screws
1A	70403-20KD	K68-523-00	Drum Brake DX20 Master Cylinder Kit: master cylinder, cap and 4 mounting screws
1B	11286-BLK	054-240-00	Disc Brake Solenoid - used with Disc brake actuators
1C	17028SA	052-017-00	Dampener Cylinder (each) 2 required
2	70404K	K68-540-00	Wear Pad Kit: upper and lower wear pads
3	70407K	K68-532-00	Emergency Stop Lever and Spring
4	70408K	K68-519-00	Actuator Pin Kit: 3 pins with retainers and pin kit
5	48986A	068-572-00	Master Cylinder Cap with internal bladder
6	50306	074-480-00	Safety Pin and Cable Assembly
7	50307K	K68-529-00	Emergency Stop Cable with Connector Link
8	70409K	K74-571-00	Latch Kit
9	70405K	068-576-00	Emergency Stop Lever Cover and Spring and 3 mounting screws
10	70406	068-560-00	Rear Cover

first, and the farthest brake on that axle first. Use a loose end of hose from the bleeder valve submerged in a clear container of brake fluid to observe bubbling (hose must be submerged into clean brake fluid to keep air from traveling back into the brake cylinder). Loosen the bleeder screw located in the wheel cylinder one turn; the system is now open to the atmosphere. The bleeding operation for that brake is complete when bubbling stops. Be sure to tighten bleeder screw securely. Each wheel cylinder must be bled until all air is out of the lines. Replenish the brake fluid during the bleeding process so the level does not fall below half full level in the master cylinder reservoir. When bleeding and testing is completed, make sure master cylinder is filled to approximately 3/8” below the top of the reservoir and filler cap is securely in place.

5. Road test trailer a short distance to activate the actuator several times. Check fluid level again. Remember, low brake fluid levels will result in reduced braking or no braking at all.
6. When testing is completed, make sure master cylinder is filled to approximately 3/8” below the top of the reservoir and filler cap is securely in place. Road test again to make sure brakes work properly.

RATED CAPACITY:

Maximum Actuator Capacity: 20,000 lbs. Gross Load; 2,000 lbs. maximum tongue load; minimum tongue weight is 5% of G.V.W.R.

The actual in-service rating is limited to that of the ball and hitch or the least rated component on the tow vehicle or trailer being used or the trailer manufacturer's G.V.W.R. shown on the certification label, whichever is lower (Note: G.V.W.R. is the Gross Vehicle Weight Rating which includes the trailer and the load weight as a Total Gross Weight).

HITCHING TRAILER

1. The vehicle, towing hitch and ball must have a rating equal to or greater than trailer G.V.W.R.

CAUTION

- A loose fit between the coupler and hitch ball can cause the actuator and hitch ball to separate, causing serious damage, injury or death. Check coupler every time prior to towing and at each stop on long trips. Always make certain that coupler latch safety pin is securely installed into coupler latch.
- After reverse maneuvering, always insert coupler latch safety pin back into coupler latch. **FAILURE TO REMOVE SAFETY PIN FROM REVERSE LOCK OUT POSITION HOLE WILL PREVENT FORWARD MOVEMENT BREAKING THAT CAN RESULT IN SERIOUS PROPERTY DAMAGE, INJURY OR DEATH.**

2. DX20 will accept 2-5/16" trailer hitch balls with a 20,000 lbs. capacity only. Trailer balls larger than 2-5/16" or out of round will not fit the coupler or may result in coupler failure. Balls smaller than 2-5/16" can cause shock loading and sudden disconnection. Make certain ball latch is in correct position to retain the hitch ball. Push latch lever down until safety latch engages the hitch ball. Always insert safety pin into forward hole as a safety lock for the hitch ball coupler prior to towing. Do not tow trailer if coupler is damaged.
3. Connect safety cables or chains using crossed pattern under tongue, or follow trailer manufacturer's directions.

CAUTION

- A minimum of 5% tongue weight and a maximum 10% tongue weight of the trailer GVWR must be positioned over the hitch ball. The Trailer tongue should be parallel to the ground. Too much weight can cause premature brake actuation and loss of control of the towing vehicle. Too little tongue weight can cause the trailer to fishtail, resulting in loss of control of the tow vehicle and trailer (total trailer weight GVWR includes weight of the trailer plus load).
- AVOID sharp turns, which can cause the actuator to bind or jackknife against the tow vehicle or cause a bend in the tongue. Either can damage the actuator causing brake failure. AVOID towing trailer across large bumps or dips that may overstress the connection between the trailer and tow vehicle, as this could result in damage to the actuator.
- Failure to install the hitch pin before towing can result in accidental opening of the coupler hitch latch which can lead to the trailer coming off of the hitch ball causing serious damage, injury or death. If pin will not fit into the latch hole, the coupler is not attached properly. Reset coupler on hitch ball.

4. Connect actuator breakaway cable carabiner to the tow vehicle only. Do not connect to the safety cables or chains.
5. The breakaway system is designed to only operate after complete separation from the trailer or if the tongue goes under the rear of the tow vehicle. The breakaway is not a parking brake. Do not use as such. If the breakaway is accidentally applied while un-hitching, insert a flat bladed screwdriver into the slot on either side of the plastic cover on top of the actuator. The screwdriver blade should go under the spring plate. Pry down on the handle of the screwdriver to release the spring plate. The E-stop arm should fall back and down when released.

CAUTION

When resetting the break away system keep hands and fingers clear as you reset the mechanism, hydraulic pressure held in the system may cause the assembly to snap back suddenly.

6. Any control devices that restrict operation of the actuator cannot be used. This includes certain sway control devices. The actuator must be free to telescope in response to braking requirements.
7. Equalizing or weight distributing hitches may be used, allow six to eight inches free chain length. DANGER: Tongue weight outside rating limits will interfere with performance of actuator, and braking system, and the tow vehicle.
8. Automatic Free-Backing (backing-up without braking action) is possible with this Actuator when supplied with an electrically operated Reverse Lock-Out Solenoid or coupled with Free-Backing drum brakes. To allow Free-Backing without either of those components installed the Operator must manually Lock-Out the Actuator movement while backing up. This is accomplished by placing a 7/16 X 5" long bolt (or comparable screwdriver) through the upper hole provided through the actuator housing. **DANGER: FAILURE TO REMOVE THE BOLT/SCREWDRIVER AFTER BACKING WILL CAUSE NO BRAKING ACTION IN NORMAL USE. REMEMBER TO ALWAYS REMOVE THE BOLT/SCREWDRIVER AFTER BACKING THE TRAILER.**
9. Important: The supplied, cable tethered, "Safety Pin" must be installed in the Coupler Latch hole (see illustration at right) during towing at all times.

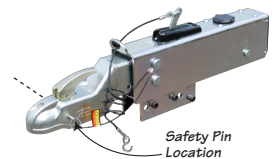

MAINTENANCE

1. Always check the brake fluid reservoir before using trailer. Make sure it is at least half full. If not, refill to approx. 3/8" below the top of the reservoir with DOT 3 brake fluid. Check for leaks and repair as required. Never reuse brake fluid.
2. To extend coupler and ball life, coat both with a thin coating of grease. Wipe clean and renew grease film each time trailer is used. A zerk fitting is installed on the coupler to make this step easier.
3. Examine the actuator for bent parts or wear each time the trailer is used. Replace parts as necessary.
4. There are no user adjustments on the actuator.
5. After excessive travel the brakes may need adjusted or bled, fluid added to the reservoir, and connections checked for leaks. Adjust per instructions found in brake installation manual. In general, back off the adjusters on drum brakes from locked position, as

required. Adjust Free-Backing brakes by rotating wheel in forward direction only. Failure to adjust may result in loss of braking. Disc brakes do not require adjustment, check for pad wear periodically.

CAUTION

The exterior of the actuator and brakes should always be flushed with fresh water after using trailer in corrosive conditions. This includes salt water, fertilizers and other corrosive materials. Before storing trailer remove brakes and clean thoroughly. It is also wise to repack the bearings at the same time. Failure to properly and adequately maintain the actuator could cause serious damage, injury or death.

6. While towing, if the actuator appears to be knocking against the hitch ball while starting or stopping, check brake fluid reservoir and fill if below 3/8" full from the top.

PLEASE NOTE THE FOLLOWING IMPORTANT INFORMATION ABOUT MAINTAINING AND OPERATING THE ACTUATOR.

- Actuator models designed for disc brakes do not have a check valve installed. Check valves are required for use with drum brakes. DO NOT use any actuator designed for drum brakes on a trailer with disc brakes installed.
- Check all system components after breakaway system is used. Replace any damaged parts with genuine Dexter parts only.
- DO NOT REUSE BRAKE FLUID. Always use fresh DOT 3 brake fluid from a fresh container. Failure to maintain proper levels of fluid in the reservoir will cause brake failure. Never use silicone based brake fluids.

BLEEDING THE BRAKES

Tools Required - a medium to large size flat blade screwdriver, a 3/16" & a 5/32" hex key wrench, a wrench to fit the bleeder valves on your brakes and brake fluid DOT 3. Do not use silicone brake fluids. This will cause seal damage and void your warranty.

1. Secure trailer on level ground. Chock wheels and/or attach trailer to the tow vehicle to keep the trailer from moving during the bleeding process
2. Use the hex key wrenches to remove the 3 hex screws holding the top black plastic cover on top of the actuator (Fig. 1 & 2).

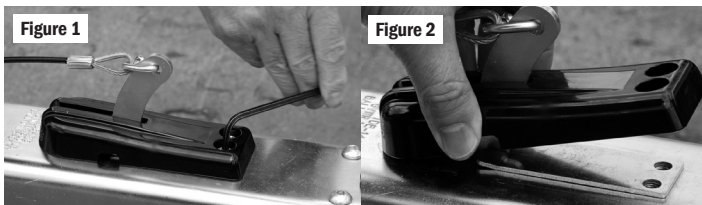

3. Slide the rectangular metal E-stop spring catch backward several inches (Fig. 3).
4. Fill master cylinder reservoir with DOT 3 brake fluid. NEVER reuse brake fluid. Use only new DOT 3 brake fluid. Never use silicone based brake fluids (Fig. 4).

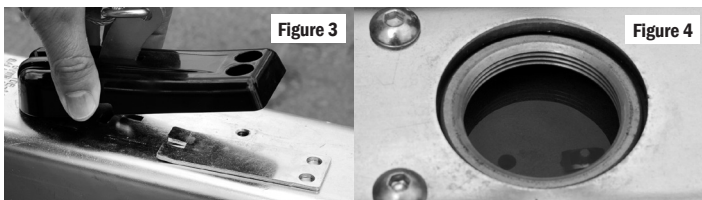

5. Insert the flat blade screwdriver in the Cable attachment loop, with the blade of the screwdriver against the E-stop arm. Pull the handle forward to pump the master cylinder (Fig. 5 & 6).

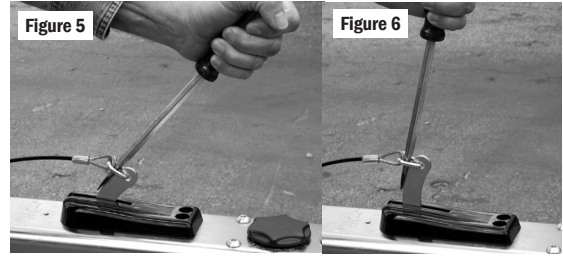

6. Repeat several times and hold to build pressure to bleed each of the brakes. Follow manufacturer's instructions for bleeding the brakes.
7. Check the master cylinder reservoir often. Do not allow the reservoir to empty. When bleeding is completed, fill reservoir to within 3/8" from the bottom of the threads. DO NOT OVER FILL.
8. Reassemble E-stop spring latch and cover (Fig. 7-11). Slide spring catch back into position lining the holes in the plate with the holes in the cover. Place plastic cover over the plate, apply Loctite® or thread locker to threads and reinstall the 3 hex head screws.

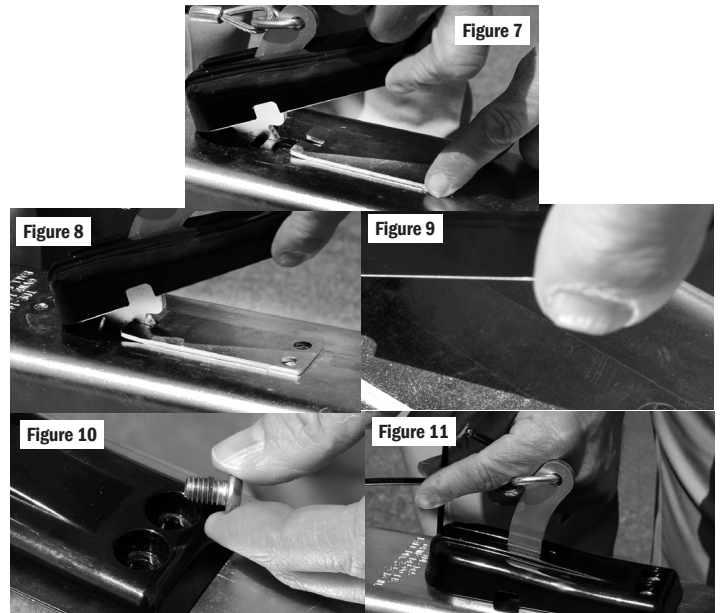

9. Test brakes in a protected area such as a parking lot or side street.

EMERGENCY STOP CABLE OR E-STOP CABLE

The DX20 actuator is supplied with an emergency stop system that applies the brakes in the unlikely situation were the trailer becomes disconnected from the tow vehicle. The cable is PVC coated and coiled for convenience. On one end the cable is connected to a lever arm on top of the actuator. The other end of the cable has a hook to connect to the tow vehicle. Should the trailer become disconnected from the tow vehicle (both coupler and/or chains) the E-stop cable would pull the lever and activate the master cylinder. A steel spring lock keeps the pressure on the brakes until manually released.

1. When towing the vehicle, connect the end of the E-stop cable to the tow vehicle. Never connect the E-stop cable to the safety chains or cables.
2. Connection point should be a position on the tow vehicle that is different from the safety cables or chains.

WARNING: IT IS POSSIBLE THAT THE E-STOP CAN BE ACTIVATED BY PULLING ON THE CABLE IN VARIOUS WAYS.

1. Forgetting to disconnect the E-stop cable from the tow vehicle and pulling tow vehicle away from the trailer. This would pull the lever and activate the brakes.
2. Stepping on the E-stop cable with enough force to pull the lever and activate the brakes.
3. Attaching the E-stop hook in a way that is too tight and causes the cable to be pulled when making turns while towing the trailer.
4. Wrapping the E-stop cable around the actuator or trailer tongue reducing the amount of free play in the cable.
5. Leaving the E-stop cable dragging on the ground, causing the cable to grab an object on the road.

RELEASING THE E-STOP

Always check the position of the E-stop lever to make sure it is not in a locked position. Lever should be able to touch the rear of the slot in the plastic cover when not activated.

1. Figure 12 shows a released E-stop lever position. Figure 13 shows an activated E-stop lever position.



Figure 12



Figure 13

2. To release, use a flat bladed screwdriver to pry up the steel E-stop spring (Fig. 14).

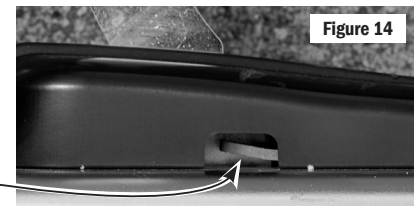

Figure 14

Place screwdriver head under the spring plate.

3. Insert flat bladed screwdriver under the steel spring plate and push the handle of the screwdriver down, prying the spring plate up to release the E-stop lever (Fig. 15).



Figure 15

4. E-stop lever should move freely after release (Fig. 16).



Figure 16

