



TOW ASSIST™

ABS & SWAY MITIGATION SYSTEM

Powered by  **BOSCH**



INSTALLATION MANUAL

TOW ASSIST ABS & SWAY MITIGATION SYSTEM

Introduction2
 Suggested Tools2
 Tow Assist Brake Control Module - “ECU”3

Trailer Requirements3
 Wheel Speed Sensor Availability.....3
 Chassis Rail Mounting Suitability.....3
 Mounting Examples.....3

Mounting3
 Universal Bracket3
 Mounting Location on the Trailer.....4
 Mounting Orientation & Accuracy4
 ECU Orientation Requirements4
 Recommended ECU Mounting Hardware4
 Recommended ECU Mounting Technique.....4
 Light Module Mounting Location.....5

Wiring.....5
 Wire Identification & Correct Connection5
 Wheel Speed Sensor Connectors.....5
 Brake Magnet Connectors5

Wiring Harness5
 Harness Routing Overview6
 Wire Harness Diagram with Breakaway Only6
 Wire Harness Diagram with On Board Battery.....6
 Power Harness7
 Axle Harness7
 Common Ground Wiring Point7

Additional Installation Steps8

ECU Initial Start Up.....9
 Valid Brake Signal from Brake Controller.....9

Configuration Software9
 Configuration File Setup.....9
 Configuration from Saved File.....10
 Verification Startup After Configuration12

Advanced Software Capabilities12
 ECU Status.....12
 System Faults12

Reference13

Limited Warranty14

ECU Mounting Template15

Introduction

 **CAUTION**

This is the safety alert symbol. It is used to alert you to potential injury hazards. Obey all safety messages that follow this symbol to avoid possible injury or death.

The purpose of this document is to detail the installation requirements and guidelines for the Tow Assist. Detail within this document is provided by Dexter as a guideline to the proper and correct installation for trailer manufacturers and installers. This installation advice is based on the design of the Tow Assist system and experience from system testing.

CAUTION

The Dexter Tow Assist system should only be installed by a qualified technician.

Installation steps listed in this manual are not meant to cover every trailer type, but provide the required elements needed to install the Tow Assist successfully. Each trailer type may require steps not individually stated but implied.

CAUTION

Please review and understand all installation manual instructions before beginning installation. Many steps are sequential so it is necessary to complete all elements as instructed.

Suggested Tools

- Zip Ties
- Wire/Cable Clamps (strain relief for wires at ECU)
- Non-Abrasive Cleaner “Rubbing Alcohol” (for light installation)
- Phillips Screwdriver/Drill Bit
- 5/16” Nut Driver Bit
- Drill & Drill Bits
- Tape Measure
- Side Cutters
- 1-1/2” Hole Saw



Scan to visit the Tow Assist Website



Scan to view video about the Tow Assist System

Tow Assist Brake Control Module - “ECU”

Below is a model of the Tow Assist Brake Control Module. This will be referred to throughout the manual as the ECU (Electronic Control Unit).

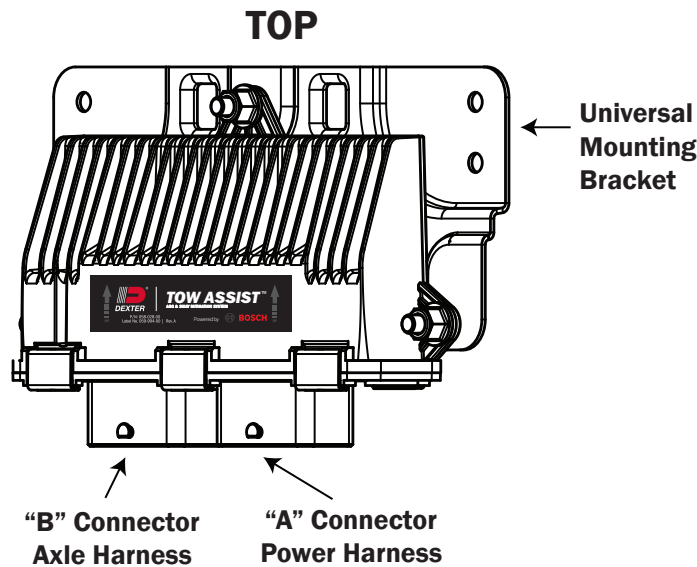

Mounting Examples

It is mandatory to provide an adequate solution to protect the ECU, axle/power harness against road debris or vertical impact. Each trailer design is unique and must be addressed individually upon installation. Failure to do so will have an effect on product life and performance. Examples of additional mounting/protection highlighted in red. 5.9” of vertical clearance is needed to protect the ECU and harness plug from road debris.

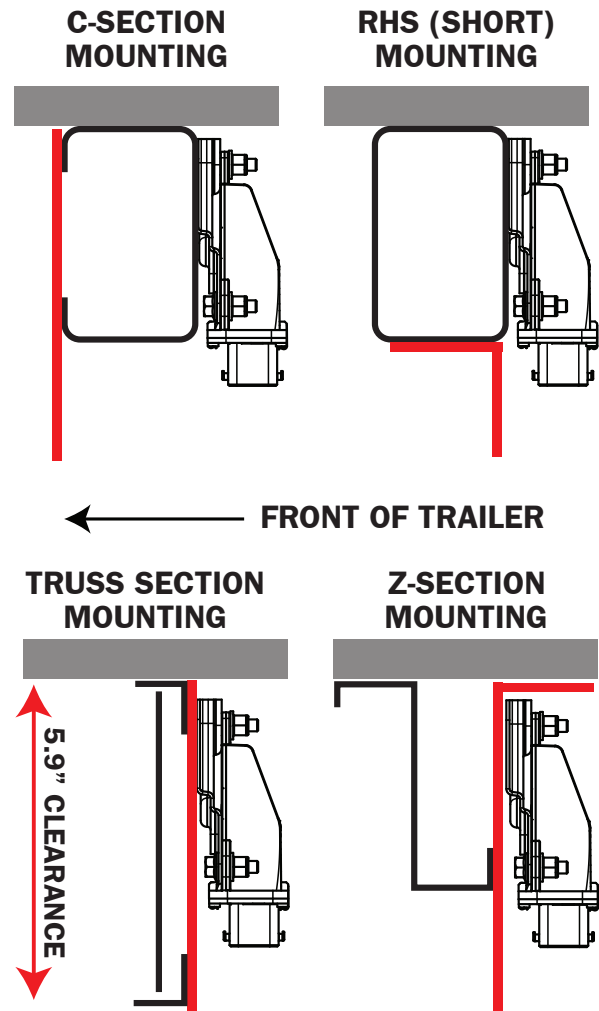

Trailer Requirements

Wheel Speed Sensor Availability

The trailer to which Tow Assist is to be fitted must have axles equipped with Tow Assist brakes and hub-drums. Wheel speed sensors are designed into the Tow Assist brake and are an integral part of the system.

Chassis Rail Mounting Suitability

Trailer chassis rail material and structure can vary significantly between different manufacturers and types of trailers. The chassis rail or cross member of the trailer is where you will mount the ECU and is therefore the major mechanical interface between the trailer and the ECU. It is important that the structural integrity of the chassis rail or cross member is suitable since it is where the ECU mounts. Unsuitable structural integrity can result in vibration and damage to the ECU.

Ideal mounting surface is a Rectangular Hollow Section (RHS) chassis rail with a minimum height of 5.9”. Area of chassis rail that contacts bracket to be within a flatness of 0.011”. The height of the chassis rail protects the ECU and connectors from on-coming projectiles and the rigidity of a rectangular steel or aluminum section provides a solid mounting surface with a reduction of ECU vibration.

Other C-Section, short height RHS, Truss and Z-Section chassis rails are allowed with a minimum height of 1.77” to meet mounting requirements. Additional mounting and/or protection surface (IE, an adapter plate) solidly fixed on the chassis rail to accommodate the vibration and protection requirements of the ECU may be required. See ECU chassis mounting examples in the following section.

Mounting

Universal Bracket

The ECU is supplied with a pre-attached Universal Mounting Bracket. The bracket provides a mounting interface between the ECU and the trailer chassis. The bracket is designed to meet the strength, stiffness and vibration requirements. The pre-attached universal mounting bracket should not be removed, adjusted or modified during installation. Selection of the ECU mounting location should always accommodate the mounting bracket as well as space to work. Damage or removal of the bracket may affect the performance of the Tow Assist system.

Mounting Location on the Trailer

The recommended mounting location for the ECU is shown below:

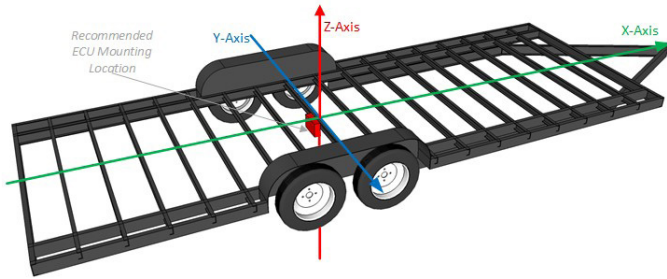

Trailer Y-Axis

- As close as possible to the centerline of the trailer, +/- 1 foot is allowed. Midway between the left and right wheels.

Trailer X-Axis

- On a chassis rail which is closest to all the braked wheels. For example, locate the ECU nearest the axle for a single axle trailer, in between the axles on a tandem axle trailer and over the center axle on triple axle trailer.
- Locate the ECU on the backside of the chassis rail or designated mounting structure. Orient the universal mounting bracket supplied on the ECU towards the front of the trailer. The Tow Assist product label should point towards the back of the trailer.

Trailer Z-Axis

- Vertical mounting position should locate the ECU as close to the floor as possible to ensure adequate protection. **IMPORTANT: THE Universal Mounting Bracket SHOULD NOT CONTACT THE FLOOR.**

Other mounting locations on the trailer are possible as long as they meet the mounting example requirements and axle harness limits. On a multi-axle installation, do not mount the ECU behind the rear axle as the increased vibration may result in performance issues.

Mounting Orientation & Accuracy

Tow Assist mounting orientation must be strictly adhered to, any deviation from these instructions may result in reduced system performance. The ECU must be mounted in the same manner as the figure below.

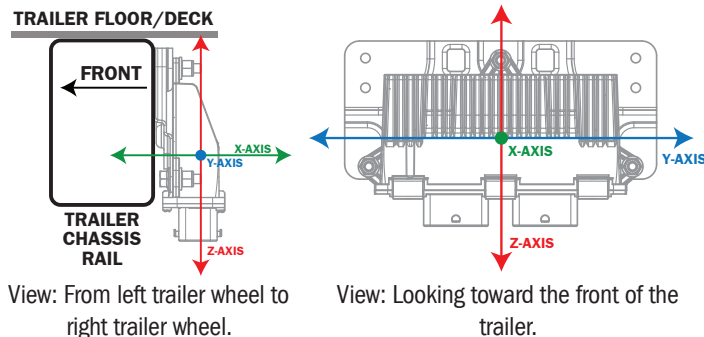

ECU Orientation Requirements

- The ECU must be mounted perpendicular to the ground. This vertical orientation (Z-Axis) should be with the harness connectors facing downward.

- The ECU should be mounted so the top edge of the Universal Mounting Bracket is parallel to the chassis or carrying surface of the unit. When mounted on a finished unit this should place the X and Y axis no more than $\pm 5^\circ$ from parallel to the ground. **NOTE: THE Universal Mounting Bracket SHOULD NOT CONTACT THE FLOOR. Allowance of 1/8" air gap is appropriate to avoid transmission of unwanted vibration.**
- The mounting location should allow for proper clearance of the axle and power harness connections as well as mounting hardware. Upon installation, the ECU and harness connections should not receive contact from external materials from the unit.
- Variation from the recommended tolerances and requirements for mounting the ECU may result in malfunction.
- In general, the best performance and robustness is achieved when the bracket is mounted with minimum tolerance. Exceeding the tolerances of these mounting requirements may result in poor performance or malfunction.

Recommended ECU Mounting Hardware

The recommended mounting hardware is a #12-14 x 1", Hex Flange Head screw. There are 4 mounting screws provided with the install kit, (Dexter part number 007-585-00). The supplied screw should be torqued to 4.4 ± 1 ft lbs (6 ± 1.5 Nm) to ensure secure mounting to the chassis rail.



Recommended ECU Mounting Technique

Upon determining the proper location and orientation, the final attachment is important. The Tow Assist install kit is supplied with hardware appropriate to attach the ECU to light gauge steel. All four holes should be pre-drilled to avoid shift during installation. Alternative frame materials may require hardware not supplied in the kit. Doing so is considered acceptable if fasteners meet or exceed those supplied with the kit. All four attachment points should be used during installation. **NOTE: DRILLING OR WELDING OF THE UNIVERSAL MOUNTING BRACKET IS NOT ALLOWED. THERE IS A MOUNTING TEMPLATE AT THE BACK OF THIS MANUAL.**

ECU Mounting Holes

Please see the ECU Mounting Template on page 15.

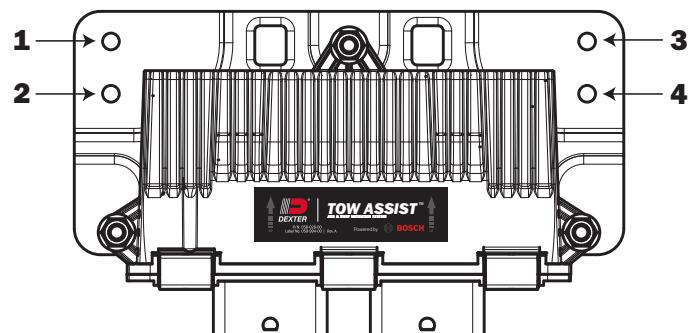

Light Module Mounting Location

The Tow Assist uses an indicator light module to notify the driver of system function and potential diagnostic codes. Driver notification is an essential part of a safety system. The light module does not have a regulated location. Dexter recommends that it be located in a place easily visible to the driver through the tow-vehicle mirror(s) while sitting in the driver's seat. Please see the suggested locations marked in red in Figure 1 and Figure 2.

Figure 1:

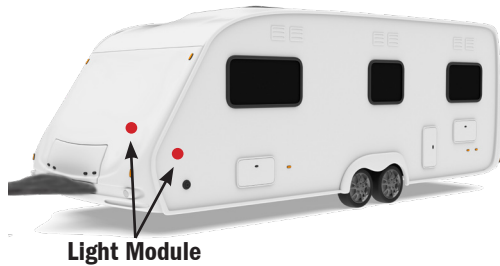
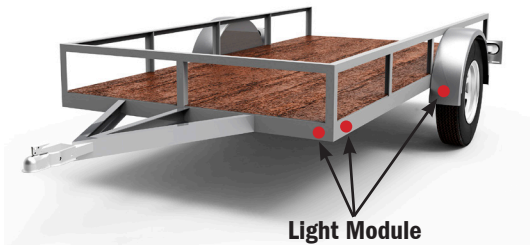

Figure 2:



Wiring

The Tow Assist wiring harness manages connection points with weatherproof connectors and nylon braided shroud to ensure system function. The wiring diagram and color code chart are meant to provide a general understanding and unit requirements to perform the harness installation section.

CAUTION

Only an experienced technician should route and install wiring.

Wire Identification & Correct Connection

Harness is color coded to match the plug on the brake to assist with right and left identification.

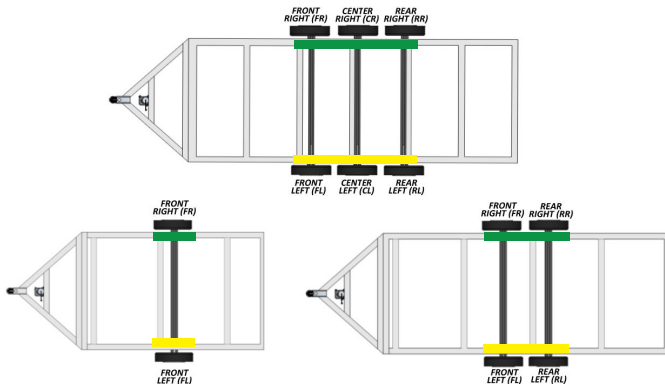

CAUTION

Proper harness must be used based on number of axles in installation. Using the incorrect harness may result in malfunction.

Trailer configuration wiring is dependent on the number of braked axles on the trailer. Please note that the Tow Assist system requires all axles to be equipped with Tow Assist brakes and hub-drums. The following configurations are valid for the Tow Assist system:

- **Single Axle Trailer:** A single front axle (FL & FR) should be selected during trailer variant configuration.
- **Tandem Axle Trailer (all axles braked):** Both braked axles Front & Rear (FL, FR, RL, RR) are selected and controlled by Tow Assist.
- **Triple Axle Trailer (all axles braked):** All braked axles Front, Center & Rear (FL, FR, CL, CR, RL, RR) are selected and controlled by Tow Assist.

Wheel Speed Sensor Connectors

Wheel Speed Sensors will connect at the brakes to the wiring harness with a 2-pin Molex® connector. They are covered with a vinyl cap, green on right side, yellow on the left and are located on the back (in board) side of the brake.

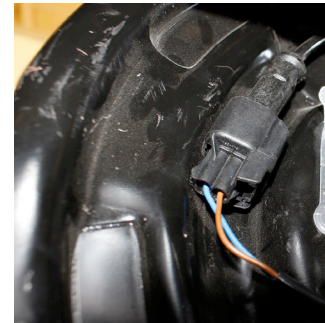

Brake Magnet Connectors

Brake magnets will connect to the wiring harness with a 2-pin Weather Pack® connector and are adjacently located to sensor connector.

Wiring Harness

Your Tow Assist system comes with a two-piece wiring harness that provides cabling to connect to the tow vehicle connections, ECU and braked wheel ends. It consists of a power/communication harness consisting of wires for power with integral 30A fuse, ground, brake request, ground connection, OBD2 communication cable with integral 4A fuse and the indicator light cable. The other half of the harness is the axle harness that comes in single, tandem and triple configurations. This harness connects the wheel speed sensors and brake magnets from each wheel to the ECU. Install the harness only after the ECU and axles have been securely mounted. Due to the variation of trailer types, this is meant as an overview, not as step by step instructions.

Tandem Axle Harness and 30' Power Harness Example

Please see Figure 3 in the reference section.

Harness Routing Overview

Diagram for Tow Assist wiring only. Additional wiring to connect the tow vehicle is still required. This is for illustration only, not exact routing locations.

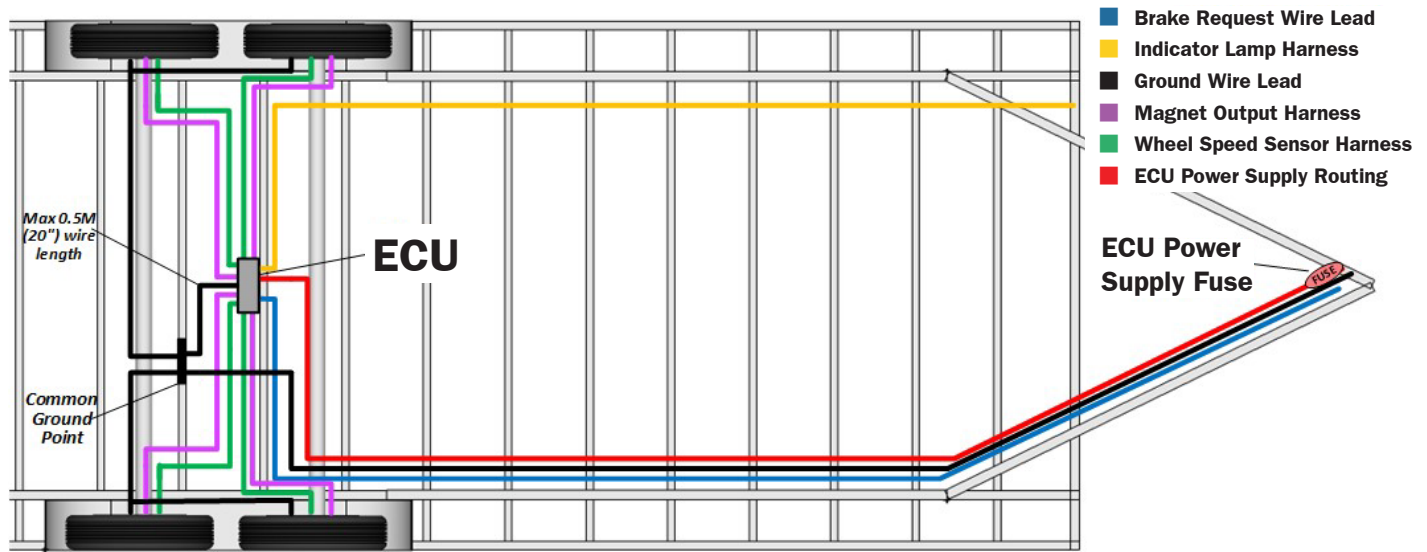

Signal	Connections	Start Point	End Point
Power Supply	Positive	Trailer Power Supply	ECU Connector
	Negative	Trailer Power Supply	Common Ground Point
Indicator Light	Operation Signal Warning Signal Ground	ECU Connector	LED Module
Brake Request	Service Brake Wire (from tow vehicle EBC)	Tow Vehicle Brake Signal (Trailer Plug)	ECU Connector
Wheel Speed Sensors	Wheel Speed Signal/Power (1-6)	ECU Connector	Wheel Speed Sensor (1-6)
Magnet Brake	Brake Magnet Signal (1-6)	ECU Connector	Brake Magnet (1-6)
Common Ground Point	ECU Ground	ECU Connector	Common Ground Point
	Brake Magnet Signal (1-6)	Brake Magnet (1-6)	Common Ground Point
	Trailer Supply Ground	Trailer Power Supply (on-board battery or tow vehicle power)	Common Ground Point

Wire Harness Diagram with Breakaway Only

*ECU not powered during breakaway feed through braking

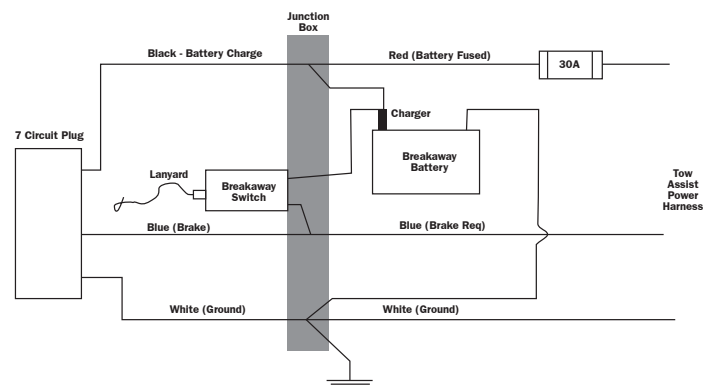

Wire Harness Diagram with On Board Battery

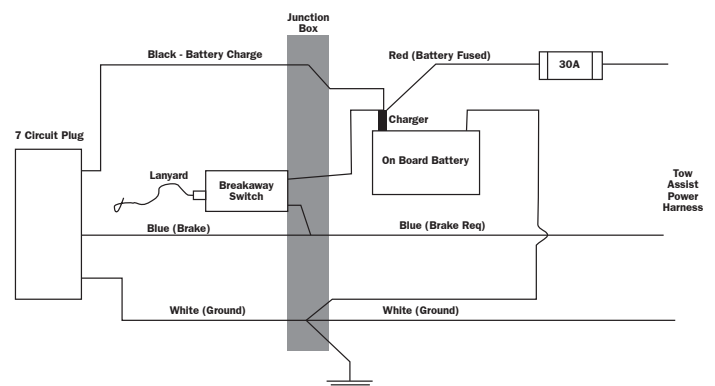

When routing the wiring harness, take care that the wiring harness is not damaged by routing via sharp corners or edges.

Make sure that the wiring harness is fixed after each connector at the ECU as described in the power harness section.

Power Harness

The power harness is designed to allow routing down the left side of the trailer from the ECU. It can be routed other ways as application dictates, but the harnesses must exit the ECU to the left. The power harness has a protective nylon braid gathering all the wires and cabling into a bundle. The harness has 18" to 30" of uncovered area to allow for end connections and mounting considerations.

- Select routing path for trailer power harness
- Identify location that the power, brake request, and ground wires will be mounted
- Identify further routing for the indicator light. The light cable extends approximately 15' further from the braid for mounting location of the light.
- Identify an environmentally protected area on trailer to mount the OBD2 communication connector. Alternately, the connector can be mounted in the trailer wiring interface box or in its own enclosure in an accessible location on the trailer provided there is approximately 4" of clearance in front of the connector for the OBD2 plug to be inserted. This connector will need to be used to complete the configuration of the ECU at the end of installation. Failure to protect OBD2 connector and/or Bluetooth® adapter from the environment will result in decreased connectivity.



- Mount an appropriate cable clamp with a rubber insert approximately 6" away from the power harness exit from the ECU. The clamp must be large enough to accommodate the power harness and the axle harness. This clamp will rigidly fix the cable assemblies for vibration resistance.

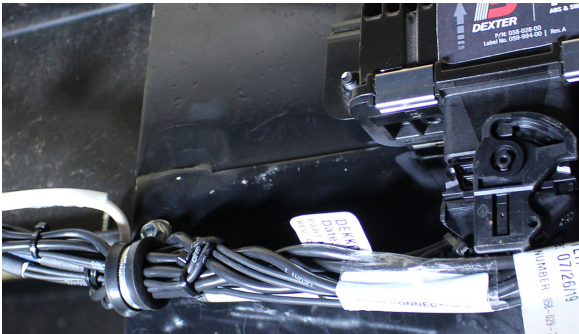

CAUTION

Improperly mounting the cable clamp will result in vibration and damage to the product.

- Route the harness as desired avoiding tight bends and excessively sharp edges locating the power wires, light harness and OBD2 extension. Route it through the cable clamp at the ECU. Utilize cable clamp as needed to avoid pinch points and sagging areas.
- DO NOT apply power to trailer harness at the junction box, tow vehicle plug or from any power location until all connections are made.
- Insert the PLUG B connector to the left side PLUG B receptacle and secure the connector latch. It locks on a feature on the connector cap. Make sure there is no orange seal sticking out of connector.



Axle Harness

CAUTION

Proper harness must be used based on number of axles in installation. Using the incorrect harness may result in malfunction.

The axle harness has lengths of cable bundles with the speed sensor connector and magnet connector that run to each wheel. The harness has colored heat shrink applied at the end of the sensor cable that coincides with a colored cap on the sensor connector mounted to the brake backing plate to aid in correct harness installation. Yellow for the left-side brakes and green for the right-side brakes. The harness also has provisions for lengths of harness that are bundled to run to the axles from the ECU connection to front or back of the trailer, primarily from the center of the trailer.

Common Ground Wiring Point

For correct operation of the ECU, the ground connector of axle wiring harness must be connected to mating plug of the power harness at ECU.



CAUTION

Failure to connect Common Ground Wiring Point will cause loss of brake magnet function.

- Select the routing path of each wheel end harness run. Much of this path will be determined by the mounting location of the ECU.
- Allow slack wire at the wheel ends to account for suspension movement.
- Secure wheel end run to frame rails or other secure points on the trailer as need to prevent harness sagging.
- Ensure that the sensor connector color identification match the sensor connector cap before discarding. Matching green to green or yellow to yellow together.
- Remove and discard cap and plug harness mating connector to sensor connector on brake backing plate.



- Plug in magnet connector to provided connector on backing plate.



- Repeat for each wheel end.
- Ensure axle harness cable routes through the cable clamp adjacent to the ECU that has the power harness.

- Insert the PLUG A connector to the right side PLUG A receptacle and secure the connector latch. The latch locks on a feature on the wire retention cap as identified. Make sure there is no orange seal sticking out of connector.

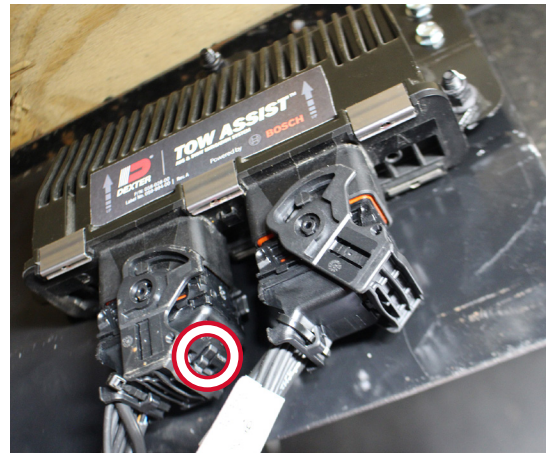

- Secure the ECU cable clamp around the harness.
- ENSURE that common ground point connector (identified in picture below) is connected to its mate. Tear off the plastic bag with the white connection lock and insert through the clearance opening at the connector latch.

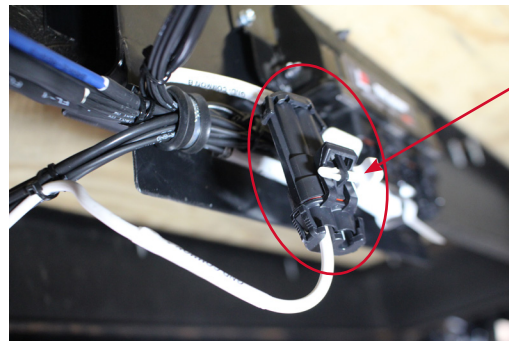

White connection lock

CAUTION

Not connecting this will result with a system fault at start up and require re-work.

Additional Installation Steps

Mount the indicator light as shown previously and connect to harness connector.



Mount the OBD2 connector securely using appropriate screws per application.

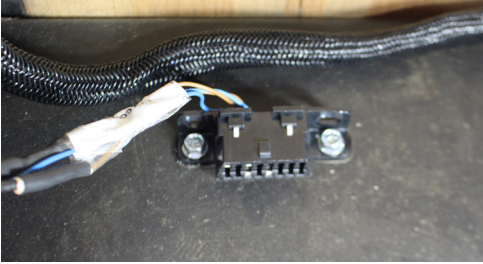

Secure both harnesses approximately 6" (but no more than 7") away from the ECU. This is needed to ensure harness tension is not transferred to the ECU well as limiting vibration input.



System function requires secure connections at a junction point behind the tow vehicle connector plug for power (red), ground (white) and brake request (blue). This illustration is for example only, exact wiring position will vary by manufacturer and application. For further explanation please see wiring diagram on page 6.

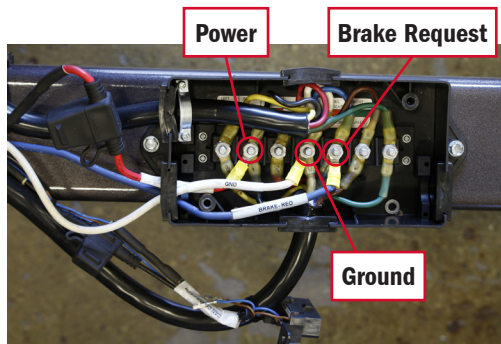

ECU Initial Start Up

The Tow Assist system is configured via the OBD2 connector in the harness. The system configuration kit is available from Dexter and can be used for multiple applications of varying axle count and wheel sizes. This kit consists of a 15' cable to connect the OBD2 plug to the OBD2 connector, a CAN to USB converter unit, and software voucher. The software requires Windows 10 64-bit operating system. Windows 7 is supported but not recommended.

At power up, the system will check for the presence of the wheel speed sensors, magnets, indicator light and wiring harness. Since this is the initial start the ECU will not be configured and the check will fail resulting in an Amber fault light.

When the ECU is **CORRECTLY** configured and power is applied, the system starts as follows:

- The indicator light will have two short color alternating bursts. This is the ECU checking for light presence.
- Then the ECU will check for the presence of the sensors.
- Then the ECU will check for the magnets. You may be able to hear the magnets activating for a short burst at each wheel in turn. Also, one can hear the relays in the ECU activating, at this time.
- The indicator light will turn off after the ECU stops clicking.
- Apply a valid brake signal to the Blue brake wire and the Tow Assist will be ready to drive and the indicator light will be green. The brake signal could be a momentary +12v application to the blue wire or a valid signal from a brake controller.

Valid Brake Signal from Brake Controller

Brake controllers available will vary somewhat on the exact signal produced at standstill. Tow Assist requires a signal that exceeds a threshold value. This value should be achieved by setting the gain to '2' or higher. This should ensure that a given controller outputs a valid signal at standstill. If Tow Assist does not go into normal operation do the following until the system indicator light is green:

1. Press and hold the brake pedal for at least 2 seconds.
2. Press and hold the brake override switch for at least 2 seconds.
3. Increase the gain setting slightly.
4. If Tow Assist does not become active, check trailer plug connections, wire and power supply to the Tow Assist and repeat steps above.

Configuration Software

Following the physical installation of the Tow Assist system, the ECU requires configuration before the ABS and Sway Mitigation will function. The configuration steps in this section identify how to use the software to assign axle count, tire size and manufacturer vehicle identification number.

The following information is needed to configure an ECU:

- Number of axles
- Tire size; Aspect ratio, width, wheel diameter so the software can calculate the rolling tire circumference for the ECU.
- VIN number (if desired to be input into ECU)

Install the software and setup per the cable kit installation instructions (059-A46-00) available at www.dexteraxle.com.

Configuration File Setup

Setup needs to be tested on the first trailer before saving into a configuration file on the PC with an appropriate identifying name. This will allow more straightforward use by production personnel for system configuration. The production personnel will select the proper parameter file and load it into the configuration tool. To set up the parameter file, follow these instructions:

1. Start the software on a computer by clicking the Dexter Tow Assist icon.

- When no configuration is loaded, the program start screen will look like the image below.

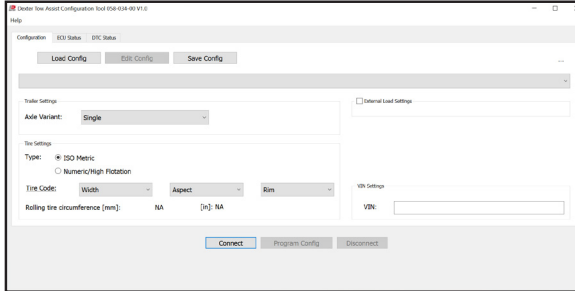

- Select the axle variant. Enter the width, aspect ratio and rim size for the tire.

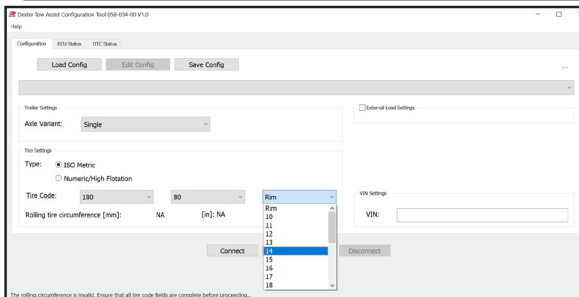
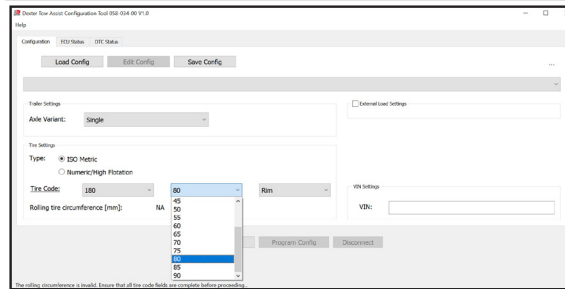
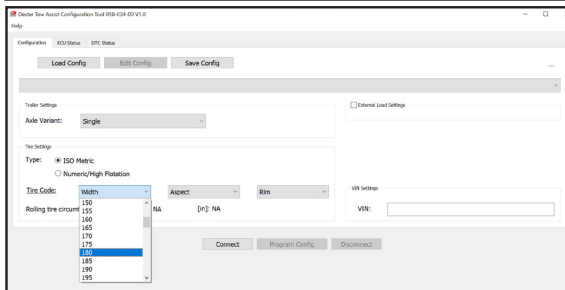
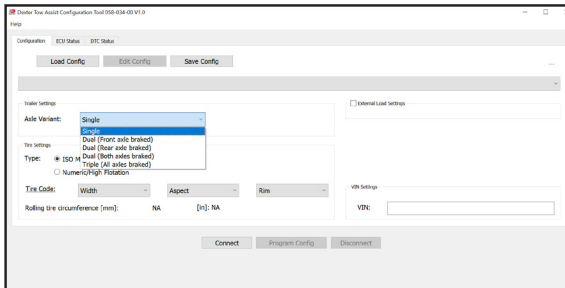

- After configuration selections have been made, click the **Save Config** button. Type in the desired file name and hit save. File type must remain as (*.cfg).

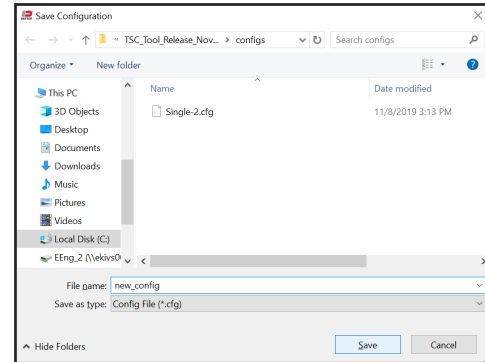
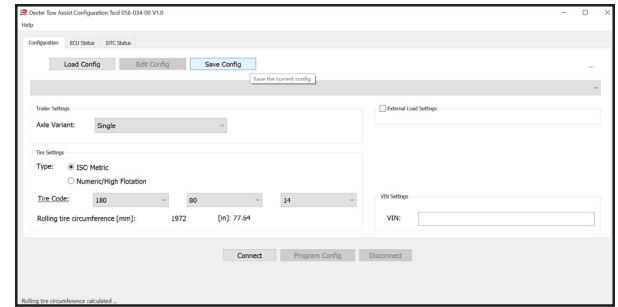

- The current data on the screen after the config file was saved can still be edited and saved under another name if needed. Reload the config file or restart the program to force data to be not editable on screen.

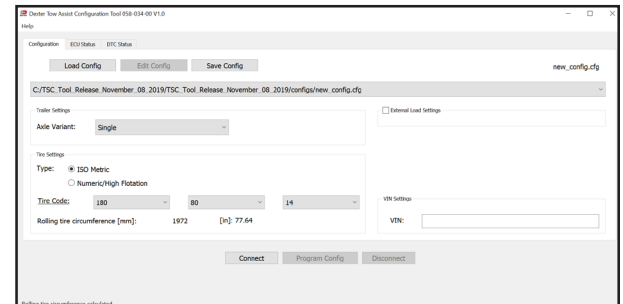

Configuration from Saved File

After parameter file has been created, the production personnel can now configure the ECU.

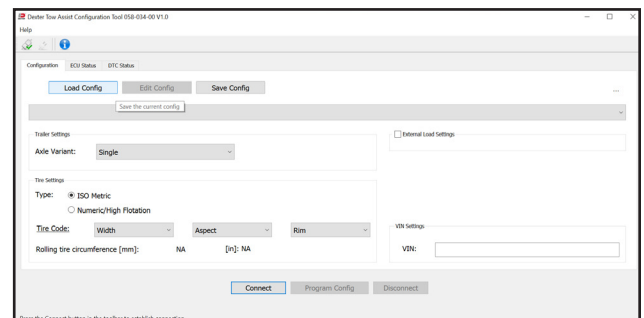

1. Open configuration and select the appropriate configuration file.

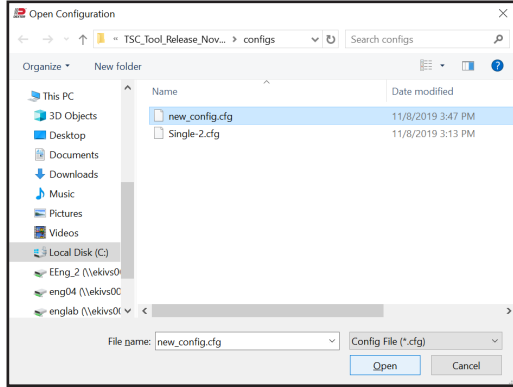

2. After file is loaded, the selection fields are grayed out to avoid accidental changes. The **Connect** button is also highlighted. Production personnel would now connect cable to OBD2 connector on trailer. The **Connect** button will remain highlighted unless an ECU is connected.

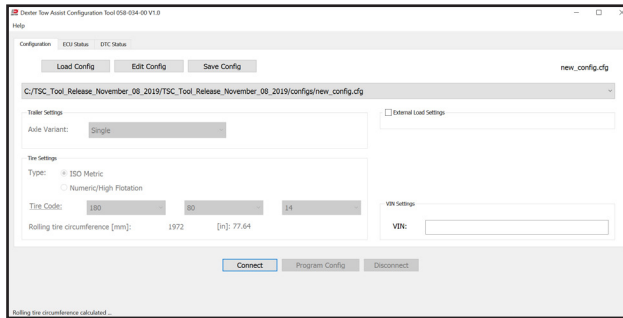

3. Plug the OBD2 connector into trailer harness
4. User has option to enter 17 character VIN number in VIN field to be written to the ECU at configuration time as shown at right bottom. Then hit **Enter** or click **Connect** with mouse.

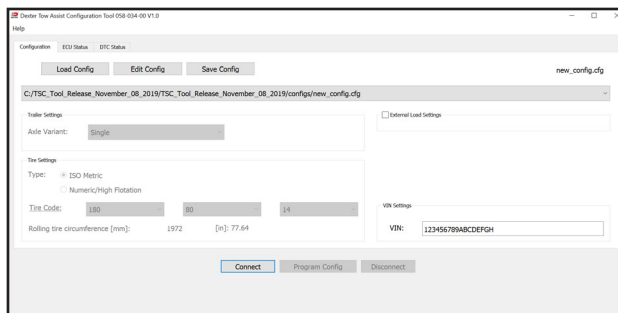
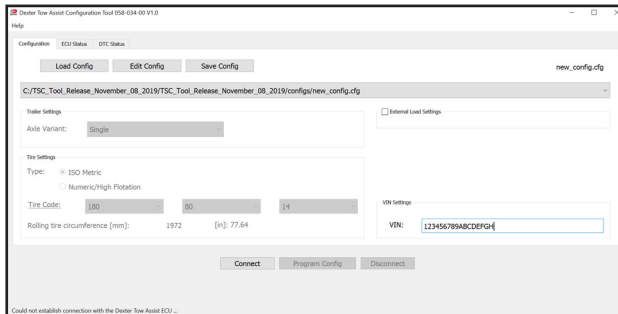

5. After **Connect** button clicked the program talks to the ECU and the Tow Assist system will flash both colors on the Indicator light while the PC is talking to Tow Assist ECU. The data in blue appears showing the current data in the ECU. This typically will be empty with new, out of the box ECUs. The **Program Config** button is highlighted ready to write data to ECU. User hits **Enter** key to configure ECU.

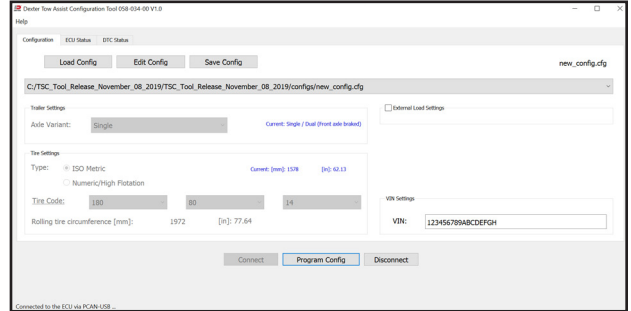

6. User hits **Enter** key to confirm Flashing (configuring/writing) ECU. When the **Enter** key is hit, the ECU will be flashed. After which the ECU will restart and the user will observe the Indicator light flashing the green and amber alternately and the magnets will energize. When complete the light goes out and the system is awaiting a brake request. When the brake request is sensed the green light will go on showing that Tow Assist is ready and operational. Operator: Hit **Enter** or click **Program ECU** with mouse.

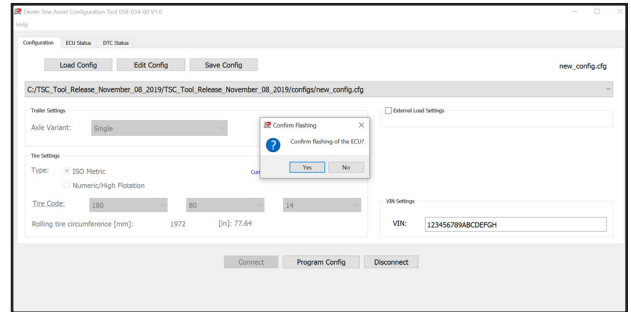

7. Program will respond when ECU "flash" is complete. User hits Enter to acknowledge.

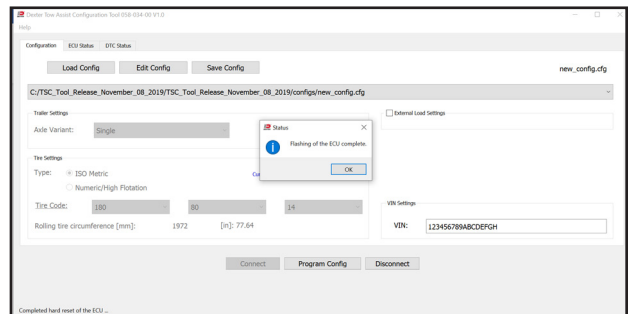

- ECU now configured and typically production personnel will hit **Enter** key or click **Disconnect** button. The indicator light will go out and the cable can be removed.

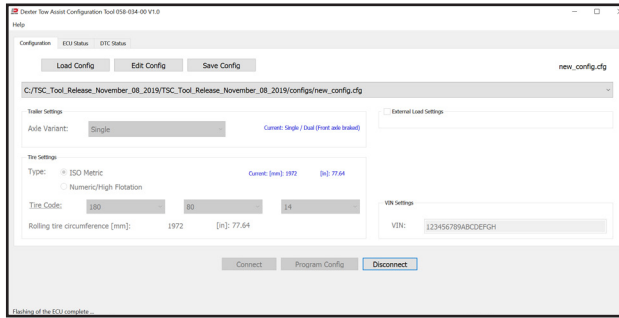

- The program is now ready for the next trailer. Repeat the process starting at step 2. Note: the VIN data stays in field so just the characters that change between trailer VINs can be edited.

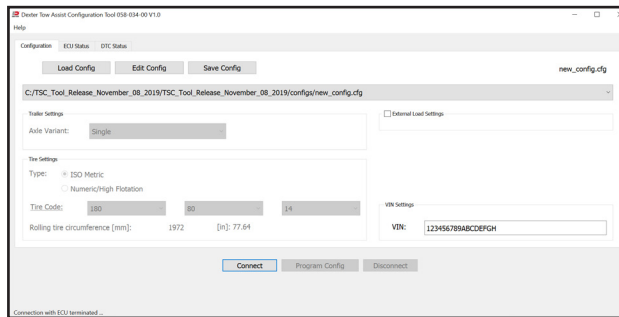

- To close the program, hit the X in the upper right corner and confirm exit in the dialog box.

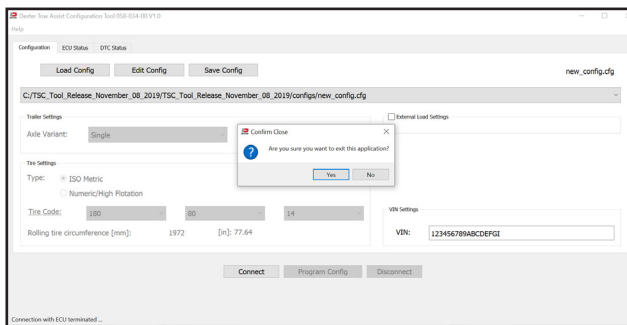

Verification Startup After Configuration

- Remove power from the trailer for about 15 seconds, until indicator light is completely out.
- Re-apply system power. The system should power up as described in Tow Assist Power Up section. The indicator light will not be on for either color at the end of a successful startup.
- Apply tow vehicle power to the brake request wire momentarily (simulate a brake application by the tow vehicle). The magnets will pull in during power application and the indicator light should light green indicating the ECU has entered drive mode and has been successfully configured.

Advanced Software Capabilities

ECU Status

While connected to an ECU click on the ECU Status tab to see the six data fields available including the VIN that has been configured and the number of miles the ECU has logged.

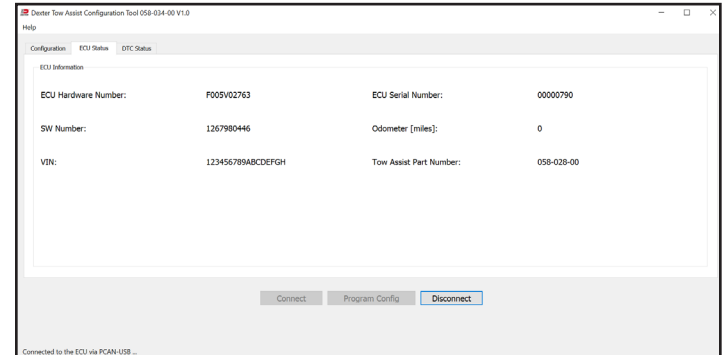

System Faults

While connected click REFRESH DTCs to see any system faults. In this case the Front right sensor was disconnected. Reconnect sensor and wait about 30 seconds. Click REFRESH DTCs to see that fault is cleared.

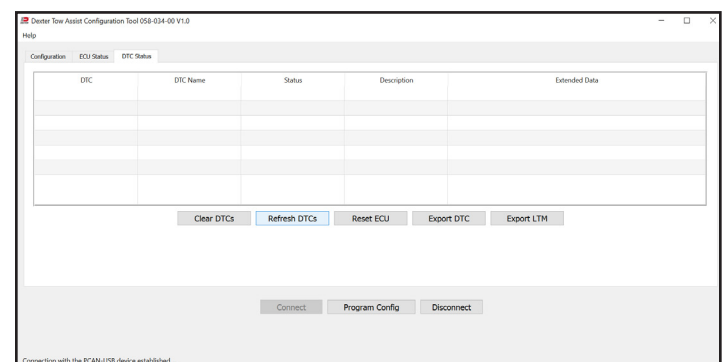
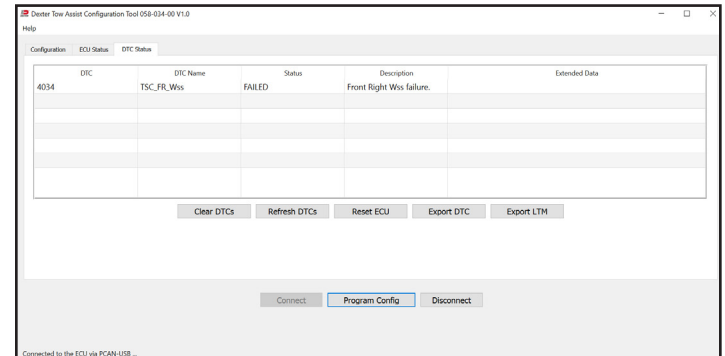

Reference

Figure 3: Example of Tandem Axle Harness and 30' Power Harness

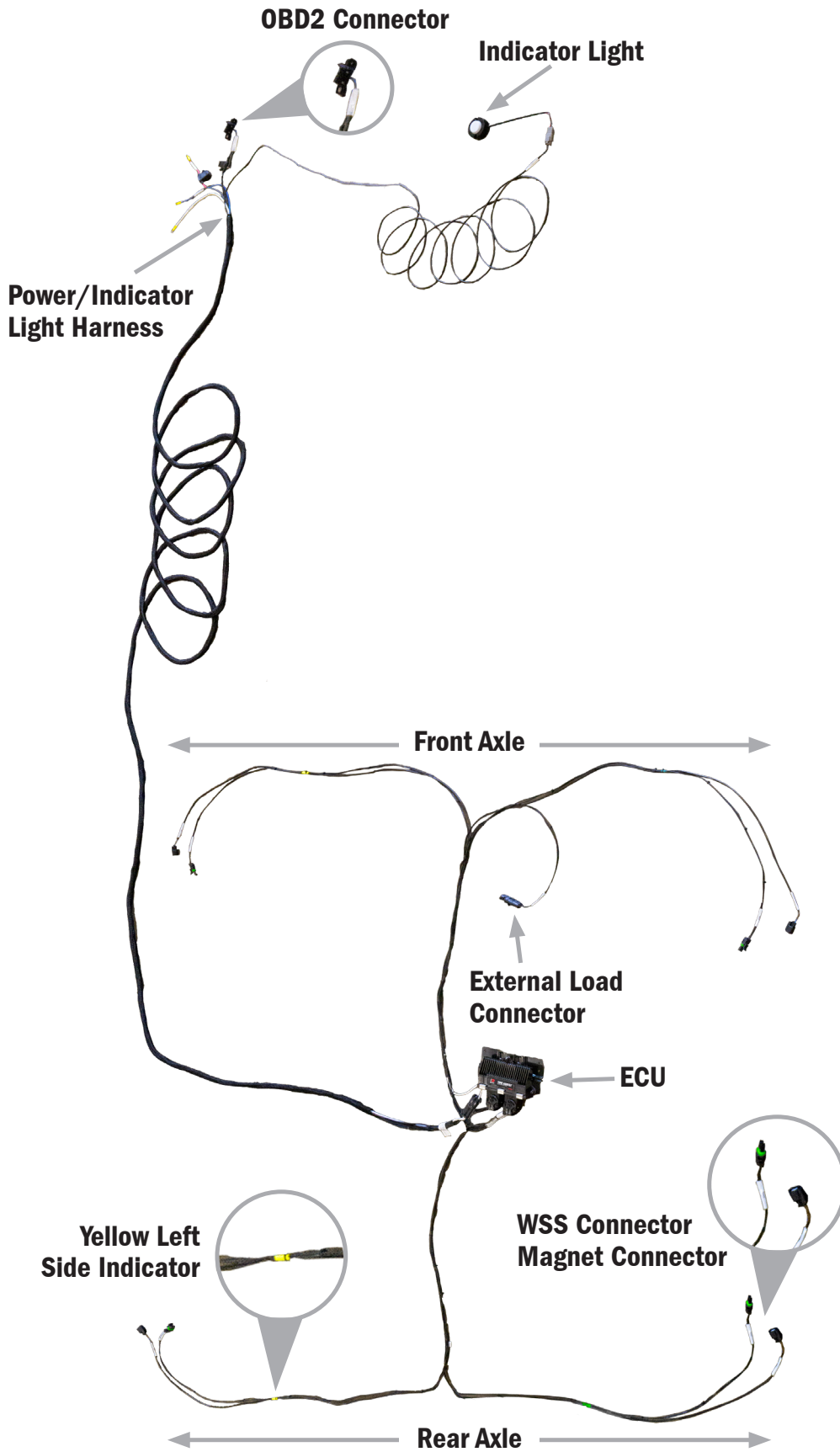

What Products Are Covered

All Dexter® Axle Company (“Dexter”) trailer axles, suspensions, and brake control systems manufactured on or after September 1, 2016, excluding Dexter 6000 series Manufactured Housing Axles. Additional exclusions include the following brands: Silent Drive by Dexter, Kodiak, Dexter’s Door and Ventilation Products, and Heavy Duty Steering and Lift Axles, which are covered by separate warranties specific to those products.

Limited 1 Year Warranty

Grease & oil seals (FOR ALL PRODUCTS), couplers, and Dexter DX6.6 Surge Actuator have a one (1) year limited warranty to the original purchaser from the date of original retail purchase.

Limited 2 Year Warranty

Dexter warrants to the original purchaser that its electric over hydraulic actuators (DX Series and BrakeRite®), Airflex® air supply components, and Tow Assist™ electronic components shall be free from defects in material and workmanship for a period of two (2) years from the date of original retail purchase.

Limited 5 Year Warranty

Dexter warrants to the original purchaser that its sprung axles, sprung suspension systems, Versa~Flex™ axles, Eliminator™ axles, hydraulic surge actuators (except Dexter DX6.6 Surge Actuator), and Dexter Genuine Replacement Parts shall be free from defects in material and workmanship for a period of five (5) years. The warranty period shall begin from the date of original retail purchase.

Limited 6 Year Warranty

Dexter warrants to the original purchaser that its Vortex™ and Vault® high performance lubrication systems shall be free from defects in material and workmanship for a period of six (6) years from the date of original retail purchase.

Limited 7 Year Warranty

Dexter warrants to the original purchaser that its Predator Series® electric brake controllers shall be free from defects in material and workmanship for a period of seven (7) years from the date of original retail purchase.

Limited 10 Year Warranty

Dexter warrants to the original purchaser that the suspension components of its Torflex® axles shall be free from defects in material and workmanship for a period of ten (10) years from the date of original retail purchase.

Exclusive Remedy

Dexter will, at its option, repair or replace the affected components of any defective axle, repair or replace the entire defective axle, or refund the lesser of the original purchase price and the then-current list price of the axle or components. In all cases, a reasonable time period must be allowed for warranty repairs to be completed. Allowance will only be made for installation costs specifically approved by Dexter.

What You Must Do

In order to make a claim under these warranties:

1. You must be the original purchaser of the trailer and/or Dexter Genuine Replacement Parts.
2. You must promptly notify Dexter after detection of any defect, but in any case within the applicable warranty period of such defect, and provide us with the axle or applicable component serial number and any substantiation of such defect which may include, but is not limited to, the return of part(s) that we may reasonably request.
3. The axles, suspensions and components must have been installed and maintained in accordance with good industry practice and

any specific Dexter recommendations, including those specified in Dexter’s current manuals.

Exclusions

These warranties do not extend to and do not cover defects caused by:

1. The connecting of brake wiring to the trailer wiring or trailer wiring to the towing vehicle wiring.
2. The attachment of the running gear to the frame.
3. Parts not supplied by Dexter.
4. Any damage whatsoever caused by or related to any alteration of the axle including welding supplemental brackets to the axle.
5. Use of an axle on a unit other than the unit to which it was originally mounted.
6. Normal wear and tear.
7. Improper alignment.
8. Improper installation.
9. Unreasonable use (including trailer overloading or improper loading and failure to provide reasonable and necessary maintenance as specified in Dexter’s current manuals including required maintenance after “Prolonged Storage”).
10. Improper torque values and torqueing of wheel nuts. (The proper torqueing procedure and torque values are contained in Dexter’s current manuals).
11. Improper or lack of maintenance.
12. Cosmetic finish or corrosion.

Limitations

1. **In all cases, Dexter reserves the right to fully satisfy its obligations under the Limited Warranties by refunding the lesser of the original purchase price and the then-current list price of the defective axle (or, if the axle has been discontinued, of the most nearly comparable current product).**
2. Dexter reserves the right to furnish for any substitute replacement component or product in the event an axle or any component of the axle is discontinued or is otherwise unavailable.
3. These warranties are nontransferable.

General

THE FOREGOING WARRANTIES ARE EXCLUSIVE AND IN LIEU OF ALL OTHER WARRANTIES, WHETHER WRITTEN, ORAL OR IMPLIED, IN FACT OR IN LAW (INCLUDING ANY WARRANTY AGAINST INFRINGEMENT OR OF MERCHANTABILITY OR FITNESS FOR A PARTICULAR PURPOSE).

These warranties give you specific legal rights, and you may also have other rights which vary from state to state.

DEXTER HEREBY EXCLUDES INCIDENTAL AND CONSEQUENTIAL DAMAGES, INCLUDING BUT NOT LIMITED TO, LOSS OF TIME, INCONVENIENCE, LOSS OF USE, TOWING FEES, TELEPHONE CALLS, COST OF MEALS OR LODGING, FOR ANY BREACH OF ANY EXPRESS OR IMPLIED WARRANTY.

Some states do not allow limitations on how long an implied warranty lasts, or the exclusion or limitation if incidental or consequential damages, so the above exclusion or limitation may not apply to you.

Inquiries regarding these warranties should be sent to:

Dexter Axle Company
P.O. Box 250
Elkhart, IN 46515

Note: Current Dexter manuals can be found at www.dexteraxle.com.

ECU Mounting Template



Make sure this template is printed to scale and the holes line up to the ECU before drilling into trailer.

NOTE: THE Universal Mounting Bracket SHOULD NOT CONTACT THE FLOOR.
Allowance of 1/8" air gap is appropriate to avoid unwanted vibration and damage to the ECU.

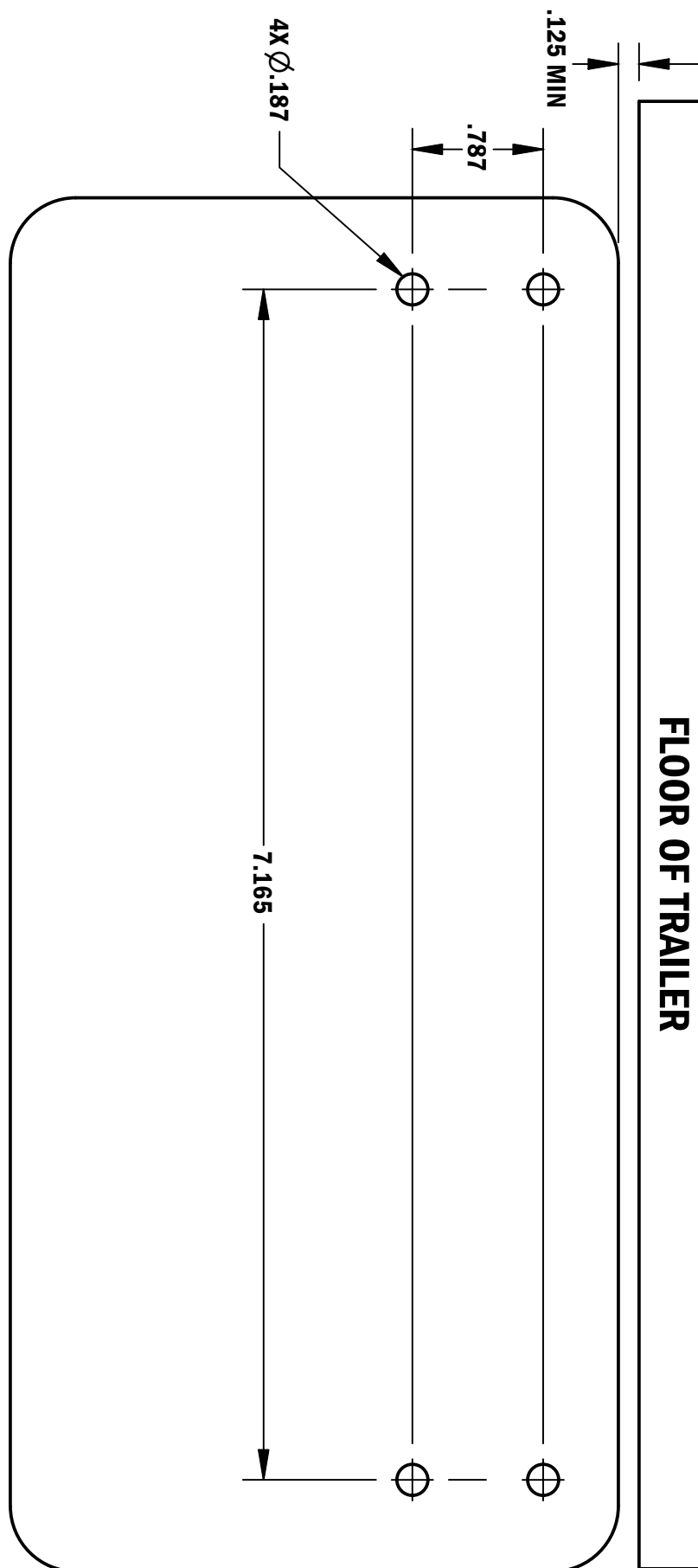

Together. Carrying what matters most.



www.dexteraxle.com

2900 Industrial Parkway East - Elkhart, IN 46516
Phone: 574-295-7888 - Fax: 574-295-8666

ISO 9001:2015 Certified

