

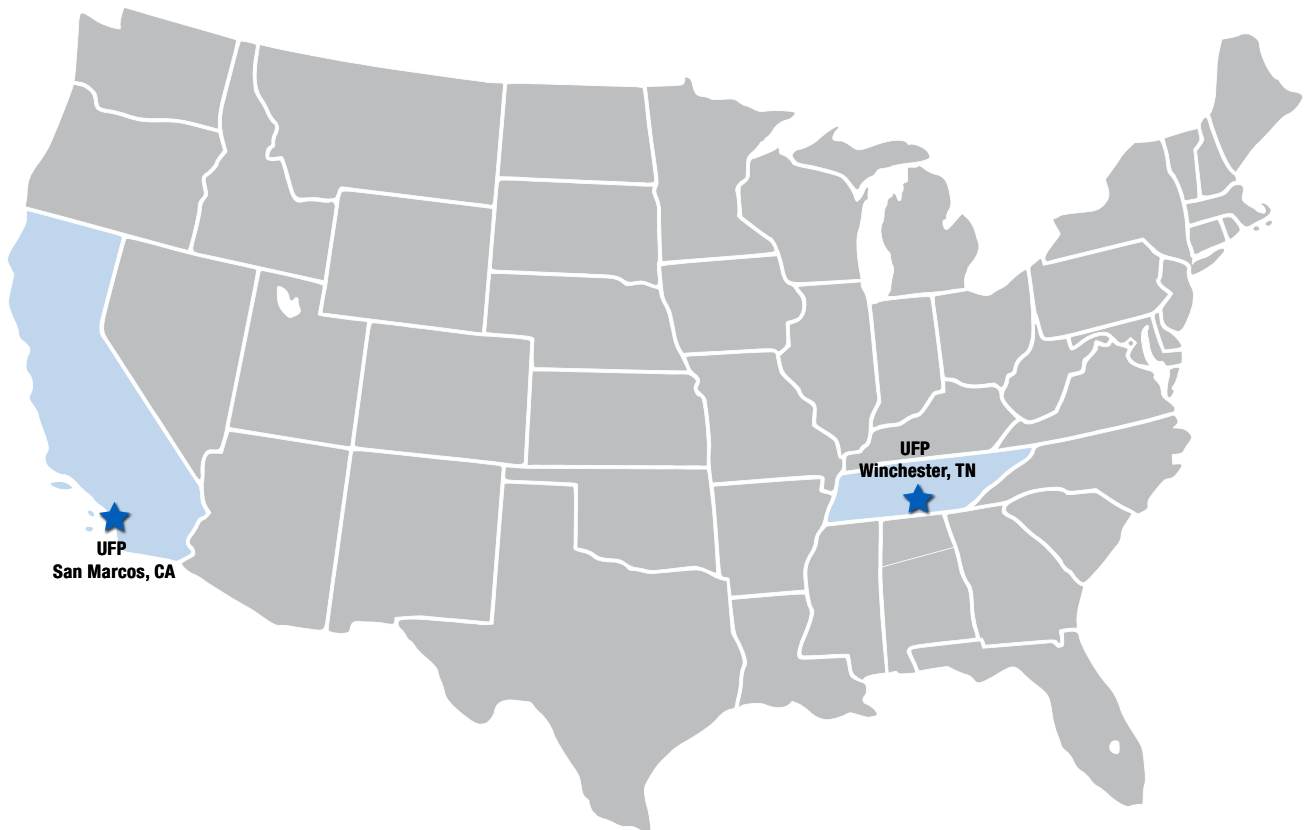

Rugged. Dependable. Geared for Innovation

GEARED FOR INNOVATION

Since 1960 Dexter has built a strong reputation as a trusted industry leader from our headquarters in Elkhart, Indiana. UFP has been a leading innovator and provider of trailer axles and brake system components to the recreation boating trailer market since 1963. Combined, Dexter and UFP provide innovative products and services to the RV, military, cargo, horse, utility, manufactured housing, and marine industries. Over 50 years later, the same principles still drive us: superior quality, continuous improvement, and unparalleled customer service.



UFP - San Marcos

135 Sunshine Lane
San Marcos, California 92069
Phone: 760-744-1610
Fax: 760-744-1616

UFP - Winchester

1041 Baxter Lane
Winchester, Tennessee 37398
Phone: 931-967-5101
Fax: 931-967-1828

NO PART OF THIS CATALOG MAY BE REPRODUCED WITHOUT DEXTER'S PERMISSION.
ALL PART NUMBERS, DIMENSIONS AND SPECIFICATIONS IN THIS CATALOG ARE SUBJECT
TO CHANGE WITHOUT NOTICE.

UFP Distributor Program

The UFP by Dexter Distributor Program is facilitated through UFP's Winchester, Tennessee facility. This program has been developed for Dexter distributors offering UFP's products as well as integrating select UFP products with Dexter products. The UFP Distributor Program offers a diverse and comprehensive product line. Initially, the program will include UFP hydraulic surge brake actuators, UFP service part kits, boxed disc brakes, and an enhanced axle offering.

As phases of the program are launched, additional information will be provided for insertion into this binder. Within the binder is contact information, catalog pages, and support materials.

Order Entry / Customer Service / Technical Questions

UFP has a knowledgeable team in place to answer product questions or assist with ordering.

Office hours are Monday - Friday, 8:00a - 4:30p Central Time.

UFP Winchester, Tennessee Contact Information: Orders & Customer Service

Email: csdexter25@dexteraxle.com (preferred order method)

Fax: 931-967-1828

Phone: 931-967-5101 x13 or toll free 800-835-9211 x13

Warranty

Please refer to the UFP Warranty Card for warranty information on UFP products.

UFP Winchester, Tennessee Warranty Contact Information:

Email: warrantyTN@dexteraxle.com (preferred method of submittal)

Fax: 931-967-1828

Phone: 931-967-5101 x13 or toll free 800-835-9211 x13

Lead Times

Initial stocking order and custom order lead times are 2-3 weeks. Standard lead time on stocked parts is 5 business days. For confirmation on which items are considered stock, contact customer service in Winchester.

Invoicing

Invoices for products purchased as part of the UFP Distributor Program are invoiced through UFP Winchester, TN. Payment should be made payable to:

Dexter Marine Products, LLC
26656 Network Place
Chicago, IL 60673-1266

Freight Policy

FOB Shipping Point (Winchester, TN)

Freight policy is subject to change. In the event of a change, written notice will be provided 30 days in advance.

UFP Overview	
Overview.....	1
Dimension Guide	
A-60, A-75, XR-84, A-84.....	4
AC-84.....	6
A-160.....	8
A-200.....	10
Couplers	
Lunette.....	12
2" / 50mm Ball.....	12
2 5/16" Ball.....	13
Actuators	
A-60: 7,500 lb, 2" / 50mm Ball.....	14
A-75: 7,500 lb, 2" / 50mm Ball.....	15
XR-84: 8,400 lb, 2" / 50mm Ball.....	16
A-84: 8,400 lb, 2 5/16" Ball.....	17
AC-84: 8,400 lb, Adjustable Channel.....	18
A-160: 16,000 lb, 2 5/16" Ball.....	20
A-200: 20,000 lb, Adjustable Channel.....	22
Service Parts	
Actuator Replacement Parts.....	24
Caliper and Pad Replacement Kits.....	28
Axle Replacement Kits.....	32
Single Boxed Hub / Rotors.....	47
Single Boxed Idler Hubs.....	49
Actuator Kits: Inner Members.....	52
Actuator Kits: Complete Assemblies.....	53
Individual & Bulk Components.....	55
Boxed Disc Brakes	
Boxed Disc Brakes: Integral Overview.....	58
Boxed Disc Brakes: Integral.....	59
Boxed Disc Brakes: Non-Integral Overview.....	66
Boxed Disc Brakes: Non-Integral.....	67
Sprung Axles	
Sprung Axle: 2500 lb - 6000 lb.....	70
Torsion Axle: 3700 lb - 7000 lb.....	78

Dexter, including UFP, uses a number of trusted trademarks to market its products in the United States, as well as internationally. All of those trademarks are protected by law, and, in addition, at least the following are registered:

Airflex®, Dexter®, E-Z Flex®, E-Z Lube®, GAL-DEX®, Nev-R-Adjust®, Nev-R-Lube®, Predator DX2®, Predator Series®, The Vault™, Torflex®, Trailer Buddy®, UFP®, Spindo®

Loctite® is a registered trademark of Henkel.

A-60, A-75, XR-84, A-84

Dexter Part Number Key

DX #: 099-075-01

099	-	075	-	0	1																												
Category Designation		Model / Inner Member Designation		Brake Type	Outer Member																												
↓		↓		↓	↓																												
<table border="1" style="width: 100%; border-collapse: collapse;"> <thead> <tr> <th>Number</th> <th>Category</th> </tr> </thead> <tbody> <tr> <td>099</td> <td>Surge Actuators</td> </tr> </tbody> </table>	Number	Category	099	Surge Actuators		<table border="1" style="width: 100%; border-collapse: collapse;"> <thead> <tr> <th>Number</th> <th>Model</th> </tr> </thead> <tbody> <tr><td>060</td><td>A-60</td></tr> <tr><td>075</td><td>A-75</td></tr> <tr><td>084</td><td>A-84</td></tr> <tr><td>184</td><td>XR-84</td></tr> <tr><td>840, 842, 860, 862</td><td>AC-84</td></tr> <tr><td>160, 162</td><td>A-160</td></tr> <tr><td>240, 242, 260, 262</td><td>A-200</td></tr> </tbody> </table>	Number	Model	060	A-60	075	A-75	084	A-84	184	XR-84	840, 842, 860, 862	AC-84	160, 162	A-160	240, 242, 260, 262	A-200		<table border="1" style="width: 100%; border-collapse: collapse;"> <thead> <tr> <th>Number</th> <th>Brake Type</th> </tr> </thead> <tbody> <tr><td>0</td><td>Drum</td></tr> <tr><td>2</td><td>Single/Tandem Disc</td></tr> <tr><td>3</td><td>Triple Disc</td></tr> </tbody> </table>	Number	Brake Type	0	Drum	2	Single/Tandem Disc	3	Triple Disc	See individual model
Number	Category																																
099	Surge Actuators																																
Number	Model																																
060	A-60																																
075	A-75																																
084	A-84																																
184	XR-84																																
840, 842, 860, 862	AC-84																																
160, 162	A-160																																
240, 242, 260, 262	A-200																																
Number	Brake Type																																
0	Drum																																
2	Single/Tandem Disc																																
3	Triple Disc																																

A-60, A-75, XR-84, A-84: Weld-On, Primed

"L"

Designed for welding to 3" x 3" or 3" x 4" straight tongue

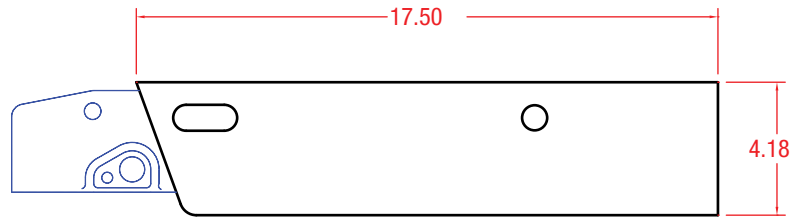

"XL"

Designed for welding to 3" x 3" or 3" x 4" straight tongue

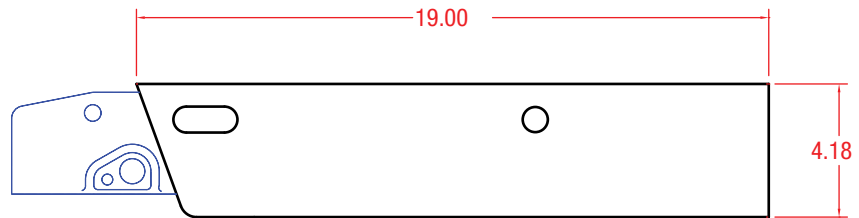

"SXL"

Designed for welding to 3" x 5" straight tongue

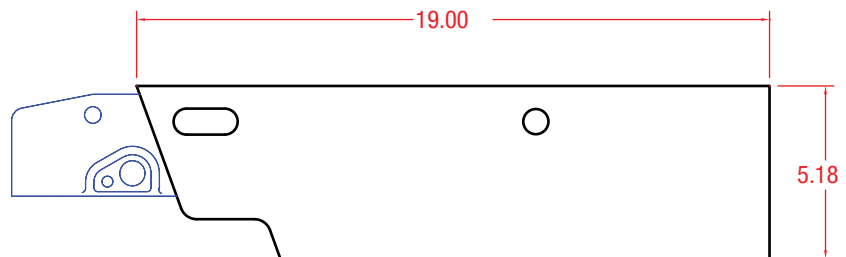

Weld-on outer member housing can be shipped separate from the inner member assemblies for ease of replacing damaged or worn parts. Separate shipments also accommodate installation of the outer housing for coating needs prior to finished assembly of the actuator.

Additional sizes and finishes are available through custom configurations. Contact your Dexter or UFP by Dexter Sales Engineer for more information.

A-60, A-75, XR-84, A-84: Bolt-On, Zinc

"S"

Designed for top mount bolting on 3" wide tongue

Compatible with Titan model 60, Tie Down model 66, Demco models with 3/4" down holes

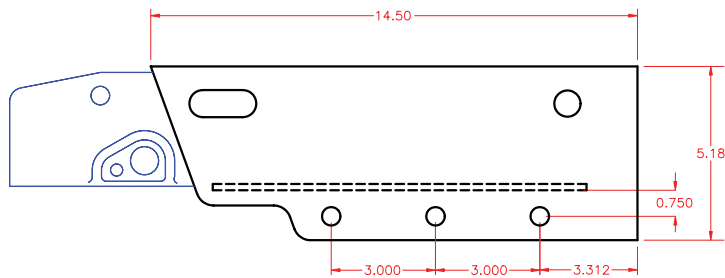

"XL"

Designed for bolting to 3" x 4" straight tongue

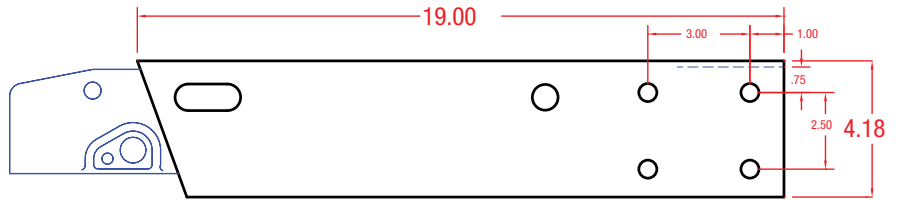

"SXL"

Designed for bolting to 3" x 5" straight tongue

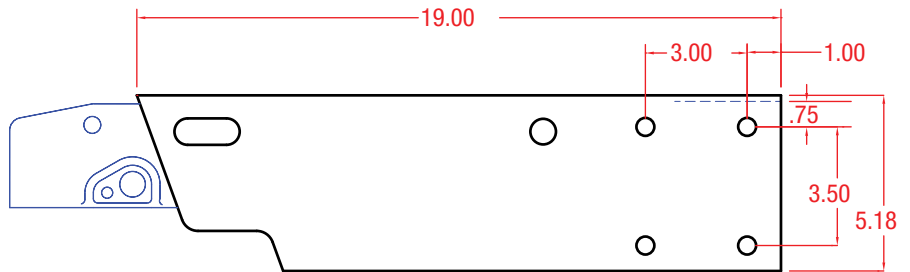

"A"

Designed for top mount bolting on 3" wide tongue

Compatible with Atwood models with 1" down holes

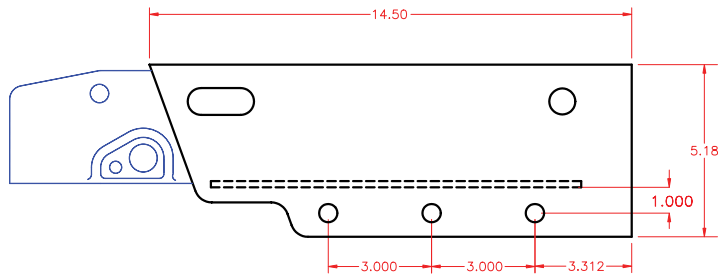

Additional sizes and finishes are available through custom configurations. Contact your Dexter or UFP by Dexter Sales Engineer for more information.

AC-84

AC-84: Weld On, Primed

"XL"

Designed for welding to 3" x 3" and 3" x 4" straight tongue

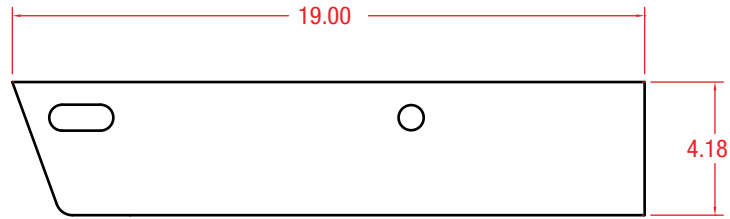

Weld-on outer member housing can be shipped separate from the inner member assemblies for ease of replacing damaged or worn parts. Separate shipments also accommodate installation of the outer housing for coating needs prior to finished assembly of the actuator.

Additional sizes and finishes are available through custom configurations. Contact your Dexter or UFP by Dexter Sales Engineer for more information.

AC-84: Bolt On, Zinc

"D3"

Bolt-on, zinc outer member

Compatible with Demco models with 3 holes

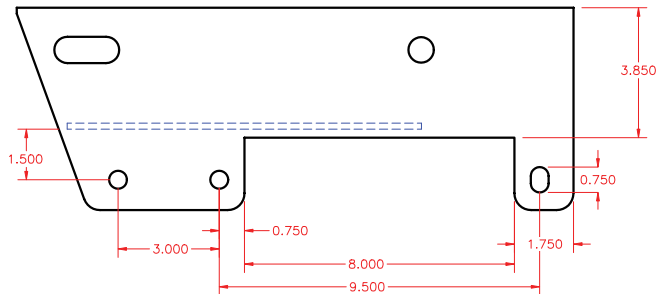

"T5"

Bolt-on, zinc outer member

Compatible with Titan model 6

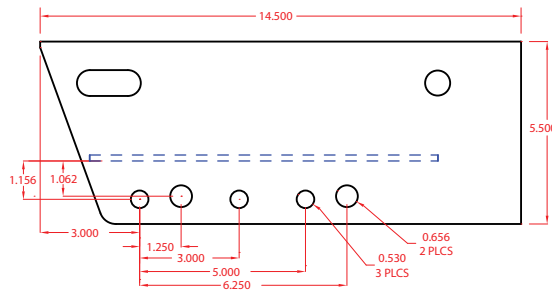

Additional sizes and finishes are available through custom configurations. Contact your Dexter or UFP by Dexter Sales Engineer for more information.

A-160

A-160: Weld On, Primed

16-inch

Designed for welding on top mount

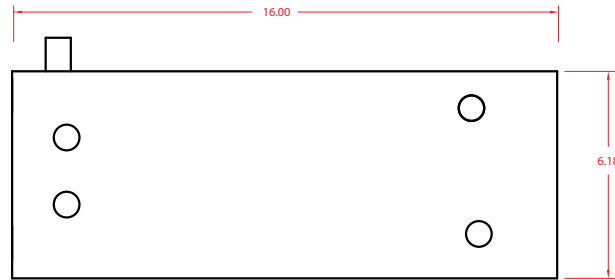

20-inch

Designed for welding on top mount

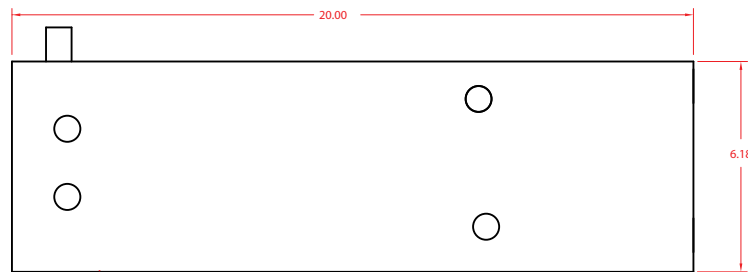

In-line

Designed for welding in line

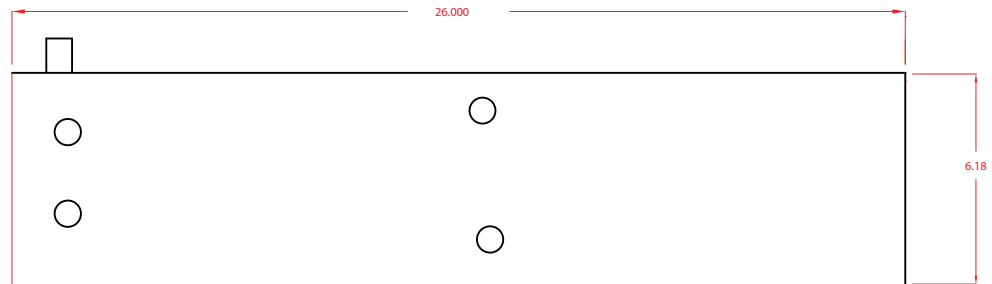

Additional sizes and finishes are available through custom configurations. Contact your Dexter or UFP by Dexter Sales Engineer for more information.

A-160: Bolt On, Zinc

Standard

Designed for bolt on standard UFP mount

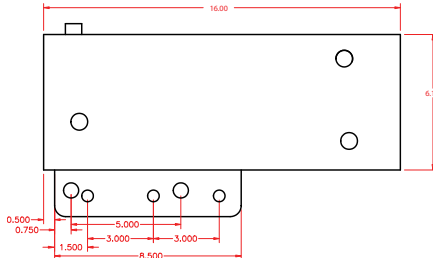

In-line

Designed for in-line bolt on

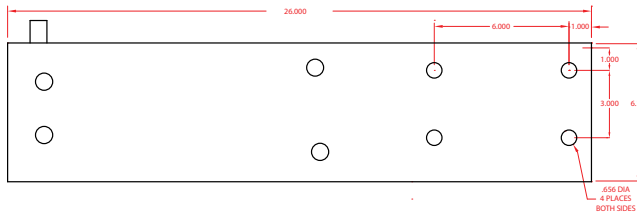

"D" Bolt On

Designed for bolt on

Compatible with Demco 5 hole models

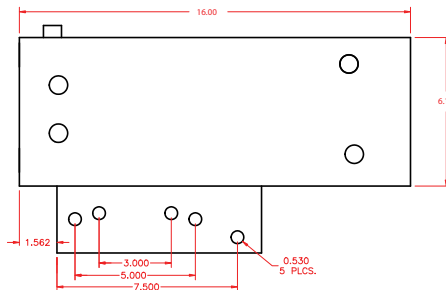

"D3" Bolt on

Designed for bolt on

Compatible with Demco 3 hole models

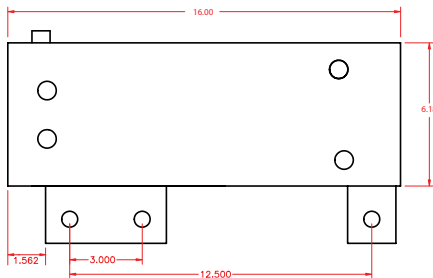

"T"

Designed for bolt on

Compatible with Titan model 10 and Tie Down 14.5K and 16.5K

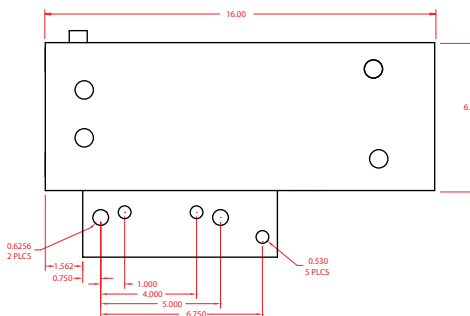

Additional sizes and finishes are available through custom configurations. Contact your Dexter or UFP by Dexter Sales Engineer for more information.

A-200

A-200: Weld On, Primed

16-inch

Designed for welding on top mount

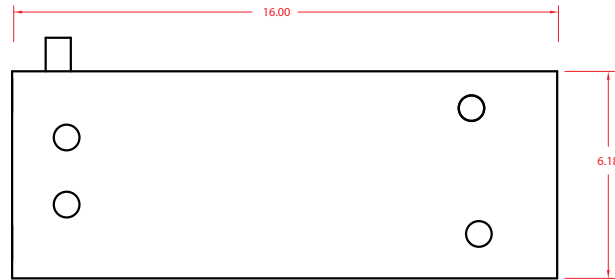

20-inch

Designed for welding on top mount

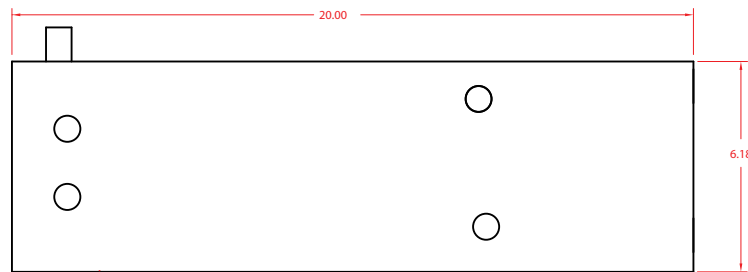

Additional sizes and finishes are available through custom configurations. Contact your Dexter or UFP by Dexter Sales Engineer for more information.

A-200: Bolt On, Zinc

Standard

Designed for bolt on standard UFP mount

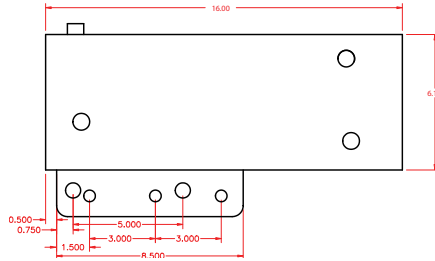

"D" Bolt On

Designed for bolt on

Compatible with Demco 5 hole models

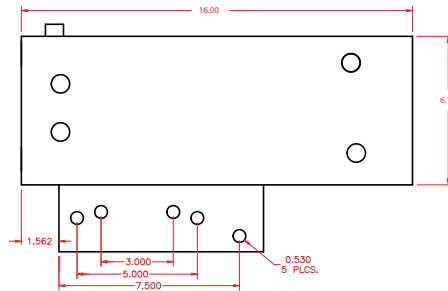

"D3" Bolt on

Designed for bolt on

Compatible with Demco 3 hole models

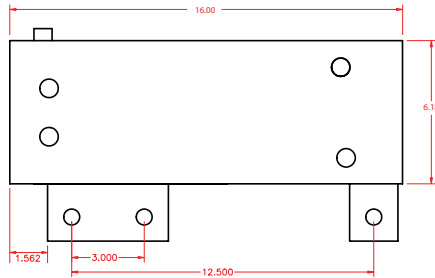

"T"

Designed for bolt on

Compatible with Titan model 20 and Tie Down 20K

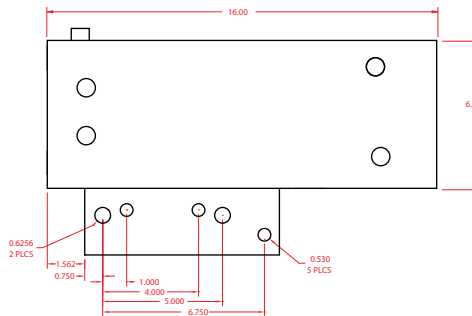

Additional sizes and finishes are available through custom configurations. Contact your Dexter or UFP by Dexter Sales Engineer for more information.

LUNETTE

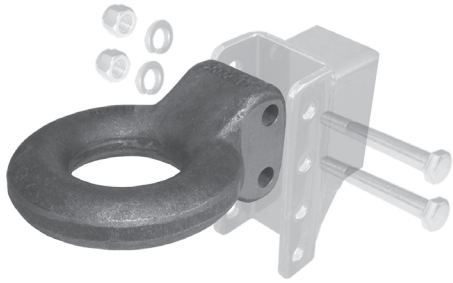

K74-014-00: Lunette

Qty	Description
1	Lunette, LR-200, 20K
2	Bolt
2	Nut, Lock
4	Washer, Flat

2" / 50mm BALL



Coupler, 5K, 2" / 50mm Ball, Straight

DX # (UFP #)	Description
074-007-00 (34099)	Coupler, CS-50, 5K, 2" / 50mm Ball, Straight, Weld On
074-008-00 (34318)	Coupler, CS-50-075, 5K, 2" / 50mm Ball, Straight, Plated, Bolt On w/ Mounting Holes 3/4" Down <i>(shown)</i>
074-009-00 (34053)	Coupler, CS-50-100, 5K, 2" / 50mm Ball, Straight, Plated, Bolt On w/ Mounting Holes 1" Down

Coupler, 5K, 2" / 50mm Ball, A-Frame



DX # (UFP #)	Description
074-010-00 (34304)	Coupler, CA-50, 5K, 2" / 50mm Ball, A-Frame, Weld On <i>(shown)</i>
074-011-00 (34100)	Coupler, CA-50, 5K, 2" / 50mm Ball, A-Frame, Weld On w/ Jack Mounting Holes

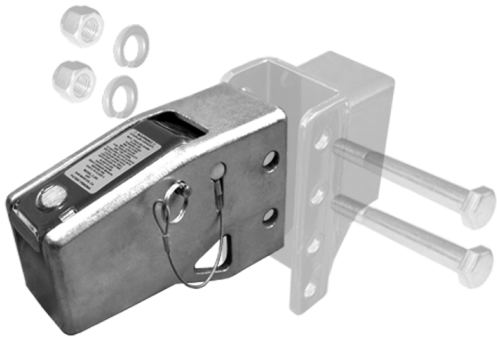

K74-028-00: Coupler, 7.7K, 2" / 50mm Ball, Bolt On

Qty	Description
1	Coupler, CB-200, 7.7K, 2" / 50mm Ball, Bolt On, Plated for Use w/ Channel Bracket
2	Bolt
2	Nut, Lock
4	Washer, Flat



Coupler, 20K, 2 5/16" Ball, Drop

DX # (UFP #)	Description
074-012-00 (40565)	Coupler, CD-200, 20K, 2 5/16" Ball, Drop, Weld On for 3" x 5" x .180" Tubing



Coupler, 20K, 2 5/16" Ball, Straight

DX # (UFP #)	Description
074-013-00 (40564)	Coupler, CS-200, 20K, 2 5/16" Ball, Straight, Weld On for 3" x 5" x .180" Tubing

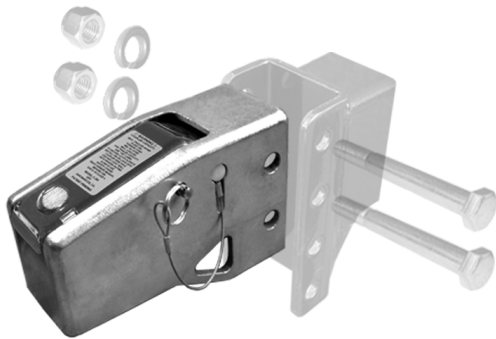

K74-019-00: Coupler, 20K, 2 5/16" Ball, Bolt On

Qty	Description
1	Coupler, CB-200, 20K, 2 5/16" Ball, Bolt On, Plated for Use w/ Channel Bracket
2	Bolt
2	Nut, Lock
4	Washer, Flat

A-60: 7,500 LB, 2" / 50mm BALL

FEATURES

The A-60 actuator's sleek square nose design pioneered a new cosmetic look in the actuator marketplace.

The unique over-center latch mechanism will only engage when the actuator is fully seated on the ball.

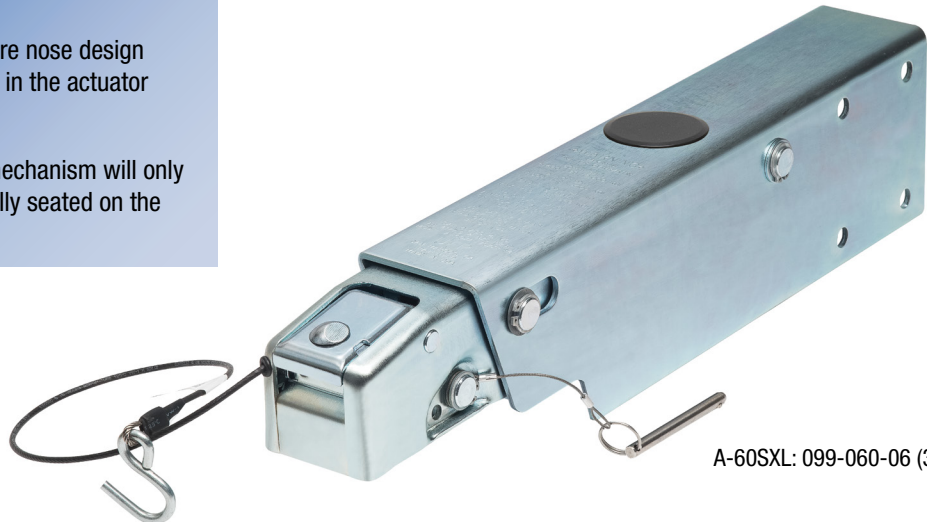

A-60SXL: 099-060-06 (36112)

DRUM BRAKE

DX # (UFP#)	Description
099-060-00 (34039)	A-60: Inner Member, Drum
099-060-01 (34628)	A-60L: Drum, Primed, Weld On, 17.5" Long (3" x 3" or 3" x 4" Straight Tongue)
099-060-02 (34703)	A-60XL: Drum, Primed, Weld On, 19" Long (3" x 3" or 3" x 4" Straight Tongue)
099-060-03 (34614)	A-60SXL: Drum, Primed, Weld On, 19" Long (3" x 5" Straight Tongue)
099-060-04 (34624)	A-60S: Drum, Zinc, Bolt On, Top Mount, 14.5" Long, holes 3/4" down
099-060-05 (35310)	A-60XL: Drum, Zinc, Bolt On, 19" Long (3" x 4" Straight Tongue)
099-060-06 (36112)	A-60SXL: Drum, Zinc, Bolt On, 19" Long (3" x 5" Straight Tongue)
099-060-08	A-60A: Drum, Zinc, Bolt On, Top Mount, 14.5" Long, holes 1" down

DISC BRAKE

DX # (UFP#)	Description
099-060-20 (34044)	A-60: Inner Member, Disc w/ Solenoid
099-060-21 (34631)	A-60L: Disc, Primed, Weld On, 17.5" Long (3" x 3" or 3" x 4" Straight Tongue)
099-060-22 (34706)	A-60XL: Disc, Primed, Weld On, 19" Long (3" x 3" or 3" x 4" Straight Tongue)
099-060-23 (47556)	A-60SXL: Disc, Primed, Weld On, 19" Long (3" x 5" Straight Tongue)
099-060-24 (34627)	A-60S: Disc, Zinc, Bolt On, Top Mount, 14.5" Long, holes 3/4" down
099-060-25 (35312)	A-60XL: Disc, Zinc, Bolt On, 19" Long (3" x 4" Straight Tongue)
099-060-26 (36114)	A-60SXL: Disc, Zinc, Bolt On, 19" Long (3" x 5" Straight Tongue)
099-060-28	A-60A: Disc, Zinc, Bolt On, Top Mount, 14.5" Long, holes 1" down

DX # in blue indicates boxed kit available. See Service Parts section for complete BOM. DX # will begin with "K" (ex. 099-060-00 boxed kit # K99-060-00).

Dexter Part Number Key

DX #: 099-060-0 6

OUTER MEMBER: A-60, A-75, A-84, XR-84

Number	Model
0	No outer member
1	"L" Primed weld on housing, 17.5" long for 3" x 3" or 3" x 4" straight tongue
2	"XL" Primed weld on housing, 19" long for 3" x 3" or 3" x 4" straight tongue
3	"SXL" Primed weld on housing, 19" long for 3" x 5" straight tongue
4	"S" Zinc bolt on housing, top mount, 14.5" long, holes 3/4" down
5	"XL" Zinc bolt on housing, 19" long for 3" x 4" straight tongue
6	"SXL" Zinc bolt on housing, 19" long for 3" x 5" straight tongue
8	"A" Zinc bolt on housing, top mount, 14.5" long, holes 1" down

FEATURES

The A-75 actuator incorporates the industry standard lever lock latch at a competitive value price point.

Unique to the A-75 actuator is a hole at the top of the ball socket acting as a visual indicator ensuring that the hitch ball is properly seated.

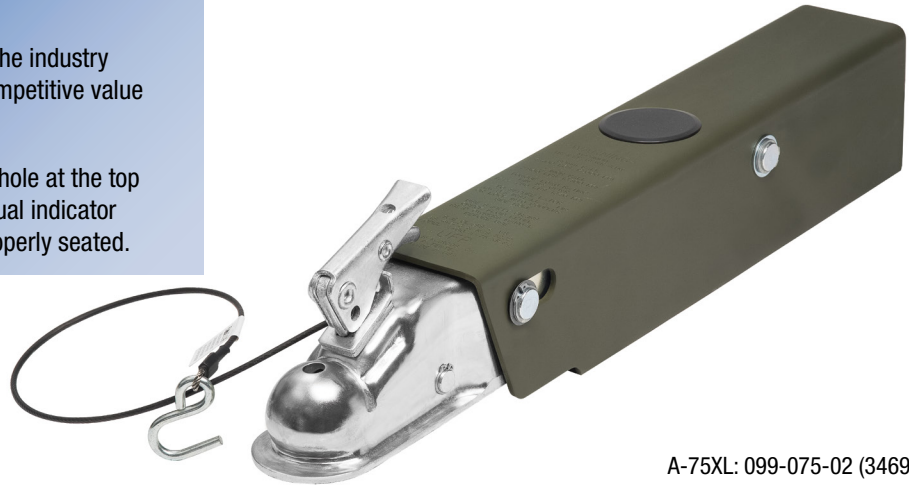

A-75XL: 099-075-02 (34691)

DRUM BRAKE

DX # (UFP#)	Description
099-075-00 (47729)	A-75: Inner Member, Drum
099-075-01 (34656)	A-75L: Drum, Primed, Weld On, 17.5" Long (3" x 3" or 3" x 4" Straight Tongue)
099-075-02 (34691)	A-75XL: Drum, Primed, Weld On, 19" Long (3" x 3" or 3" x 4" Straight Tongue)
099-075-03 (34733)	A-75SXL: Drum, Primed, Weld On, 19" Long (3" x 5" Straight Tongue)
099-075-04 (34690)	A-75S: Drum, Zinc, Bolt On, Top Mount, 14.5" Long, holes 3/4" down
099-075-05 (34650)	A-75XL: Drum, Zinc, Bolt On, 19" Long (3" x 4" Straight Tongue)
099-075-06 (34604)	A-75SXL: Drum, Zinc, Bolt On, 19" Long (3" x 5" Straight Tongue)
099-075-08	A-75A: Drum, Zinc, Bolt On, Top Mount, 14.5" Long, holes 1" down

DISC BRAKE

DX # (UFP#)	Description
099-075-20 (47724)	A-75: Inner Member, Disc w/ Solenoid
099-075-21 (34667)	A-75L: Disc, Primed, Weld On, 17.5" Long (3" x 3" or 3" x 4" Straight Tongue)
099-075-22 (34607)	A-75XL: Disc, Primed, Weld On, 19" Long (3" x 3" or 3" x 4" Straight Tongue)
099-075-23 (47218)	A-75SXL: Disc, Primed, Weld On, 19" Long (3" x 5" Straight Tongue)
099-075-24 (47102)	A-75S: Disc, Zinc, Bolt On, Top Mount, 14.5" Long, holes 3/4" down
099-075-25 (34787)	A-75XL: Disc, Zinc, Bolt On, 19" Long (3" x 4" Straight Tongue)
099-075-26 (34621)	A-75SXL: Disc, Zinc, Bolt On, 19" Long (3" x 5" Straight Tongue)
099-075-28	A-75A: Disc, Zinc, Bolt On, Top Mount, 14.5" Long, holes 1" down

DX # in blue indicates boxed kit available. See Service Parts section for complete BOM. DX # will begin with "K" (ex. 099-060-00 boxed kit # K99-060-00).

Dexter Part Number Key

DX #: 099-075-0 2

OUTER MEMBER: A-60, A-75, A-84, XR-84	
Number	Model
0	No outer member
1	"L" Primed weld on housing, 17.5" long for 3" x 3" or 3" x 4" straight tongue
2	"XL" Primed weld on housing, 19" long for 3" x 3" or 3" x 4" straight tongue
3	"SXL" Primed weld on housing, 19" long for 3" x 5" straight tongue
4	"S" Zinc bolt on housing, top mount, 14.5" long, holes 3/4" down
5	"XL" Zinc bolt on housing, 19" long for 3" x 4" straight tongue
6	"SXL" Zinc bolt on housing, 19" long for 3" x 5" straight tongue
8	"A" Zinc bolt on housing, top mount, 14.5" long, holes 1" down

XR-84: 8,400 LB, 2" / 50mm BALL

FEATURES

UFP's newest design features a self-latching robust cast front end achieving a capacity of 8,400 lb with a 2" ball.

The XR-84 actuator is a best-in-class and is positioned as an excellent up-sell opportunity.

The XR-84 inner housing is interchangeable with any UFP actuator 8,400 lbs and below.



XR-84S: 099-184-04 (40222)

DRUM BRAKE

DX # (UFP#)	Description
099-184-00 (40204)	XR-84: Inner Member, Drum
099-184-01 (40227)	XR-84L: Drum, Primed, Weld On, 17.5" Long (3" x 3" or 3" x 4" Straight Tongue)
099-184-02 (40235)	XR-84XL: Drum, Primed, Weld On, 19" Long (3" x 3" or 3" x 4" Straight Tongue)
099-184-03 (40229)	XR-84SXL: Drum, Primed, Weld On, 19" Long (3" x 5" Straight Tongue)
099-184-04 (40222)	XR-84S: Drum, Zinc, Bolt On, 14.5" Long, holes 3/4" down
099-184-05 (40233)	XR-84XL: Drum, Zinc, Bolt On, 19" Long (3" x 4" Straight Tongue)
099-184-06 (40240)	XR-84SXL: Drum, Zinc, Bolt On, 19" Long (3" x 5" Straight Tongue)
099-184-08	XR-84A: Drum, Zinc, Bolt On, 14.5" Long, holes 1" down

DISC BRAKE

DX # (UFP#)	Disc	Description
099-184-20 (40202)	Single/Tandem	XR-84: Inner Member, Disc w/ Solenoid
099-184-30 (40203)	Triple	
099-184-21 (40234)	Single/Tandem	XR-84L: Disc, Primed, Weld On, 17.5" Long (3" x 3" or 3" x 4" Straight Tongue)
099-184-31 (40226)	Triple	
099-184-22 (40237)	Single/Tandem	XR-84XL: Disc, Primed, Weld On, 19" Long (3" x 3" or 3" x 4" Straight Tongue)
099-184-32 (40238)	Triple	
099-184-23 (40239)	Single/Tandem	XR-84SXL: Disc, Primed, Weld On, 19" Long (3" x 5" Straight Tongue)
099-184-33 (40228)	Triple	
099-184-24 (40220)	Single/Tandem	XR-84S: Disc, Zinc, Bolt On, Top Mount, 14.5" Long, holes 3/4" down
099-184-34 (40221)	Triple	
099-184-25 (40231)	Single/Tandem	XR-84XL: Disc, Zinc, Bolt On, 19" Long (3" x 4" Straight Tongue)
099-184-35 (40232)	Triple	
099-184-26 (40242)	Single/Tandem	XR-84SXL: Disc, Zinc, Bolt On, 19" Long (3" x 5" Straight Tongue)
099-184-36 (40243)	Triple	
099-184-28	Single/Tandem	XR-84A: Disc, Zinc, Bolt On, Top Mount, 14.5" Long, holes 1" down
099-184-38	Triple	

DX # in blue indicates boxed kit available. See Service Parts section for complete BOM. DX # will begin with "K" (ex. 099-060-00 boxed kit # K99-060-00).

Dexter Part Number Key

DX #: 099-184-0 4

OUTER MEMBER: A-60, A-75, A-84, XR-84

Number	Model
0	No outer member
1	"L" Primed weld on housing, 17.5" long for 3" x 3" or 3" x 4" straight tongue
2	"XL" Primed weld on housing, 19" long for 3" x 3" or 3" x 4" straight tongue
3	"SXL" Primed weld on housing, 19" long for 3" x 5" straight tongue
4	"S" Zinc bolt on housing, top mount, 14.5" long, holes 3/4" down
5	"XL" Zinc bolt on housing, 19" long for 3" x 4" straight tongue
6	"SXL" Zinc bolt on housing, 19" long for 3" x 5" straight tongue
8	"A" Zinc bolt on housing, top mount, 14.5" long, holes 1" down

FEATURES

The A-84 actuator's sleek square nose design pioneered a new cosmetic look in the actuator marketplace.

The unique over-center latch mechanism will only engage when the actuator is fully seated on the ball.



A-84L: 099-084-01 (40323)

A-84: 8,400 LB, 2 5/16" BALL

DRUM BRAKE

DX # (UFP#)	Description
099-084-00 (40330)	A-84: Inner Member, Drum
099-084-01 (40323)	A-84L: Drum, Primed, Weld On, 17.5" Long (3" x 3" or 3" x 4" Straight Tongue)
099-084-02 (40334)	A-84XL: Drum, Primed, Weld On, 19" Long (3" x 3" or 3" x 4" Straight Tongue)
099-084-03 (40327)	A-84SXL: Drum, Primed, Weld On, 19" Long (3" x 5" Straight Tongue)
099-084-04 (40332)	A-84S: Drum, Zinc, Bolt On, Top Mount, 14.5" Long
099-084-05 (40316)	A-84XL: Drum, Zinc, Bolt On, 19" Long (3" x 4" Straight Tongue)
099-084-06 (40318)	A-84SXL: Drum, Zinc, Bolt On, 19" Long (3" x 5" Straight Tongue)
099-084-08	A-84A: Drum, Zinc, Bolt On, 14.5" Long, holes 1" down

DISC BRAKE

DX # (UFP#)	Disc	Description
099-084-20 (40320)	Single/Tandem	A-84: Inner Member, Disc w/ Solenoid
099-084-30 (40330)	Triple	
099-084-21 (40325)	Single/Tandem	A-84L: Disc, Primed, Weld On, 17.5" Long (3" x 3" or 3" x 4" Straight Tongue)
099-084-31 (40326)	Triple	
099-084-22 (40336)	Single/Tandem	A-84XL: Disc, Primed, Weld On, 19" Long (3" x 3" or 3" x 4" Straight Tongue)
099-084-32 (40337)	Triple	
099-084-23 (40329)	Single/Tandem	A-84SXL: Disc, Primed, Weld On, 19" Long (3" x 5" Straight Tongue)
099-084-33 (40338)	Triple	
099-084-24 (40331)	Single/Tandem	A-84S: Disc, Zinc, Bolt On, Top Mount, 14.5" Long
099-084-34 (40315)	Triple	
099-084-25 (40404)	Single/Tandem	A-84XL: Disc, Zinc, Bolt On, 19" Long (3" x 4" Straight Tongue)
099-084-35 (40317)	Triple	
099-084-26 (40321)	Single/Tandem	A-84SXL: Disc, Zinc, Bolt On, 19" Long (3" x 5" Straight Tongue)
099-084-36 (40322)	Triple	
099-084-28	Single/Tandem	A-84A: Disc, Zinc, Bolt On, Top Mount, 14.5" Long, holes 1" down
099-084-38	Triple	

DX # in blue indicates boxed kit available. See Service Parts section for complete BOM. DX # will begin with "K" (ex. 099-060-00 boxed kit # K99-060-00).

Dexter Part Number Key

DX #: 099-084-01

OUTER MEMBER: A-60, A-75, A-84, XR-84	
Number	Model
0	No outer member
1	"L" Primed weld on housing, 17.5" long for 3" x 3" or 3" x 4" straight tongue
2	"XL" Primed weld on housing, 19" long for 3" x 3" or 3" x 4" straight tongue
3	"SXL" Primed weld on housing, 19" long for 3" x 5" straight tongue
4	"S" Zinc bolt on housing, top mount, 14.5" long, holes 3/4" down
5	"XL" Zinc bolt on housing, 19" long for 3" x 4" straight tongue
6	"SXL" Zinc bolt on housing, 19" long for 3" x 5" straight tongue
8	"A" Zinc bolt on housing, top mount, 14.5" long, holes 1" down

FEATURES

The AC-84 actuator offers an adjustable channel front allowing a variety of bolt on attachments and mounting heights.

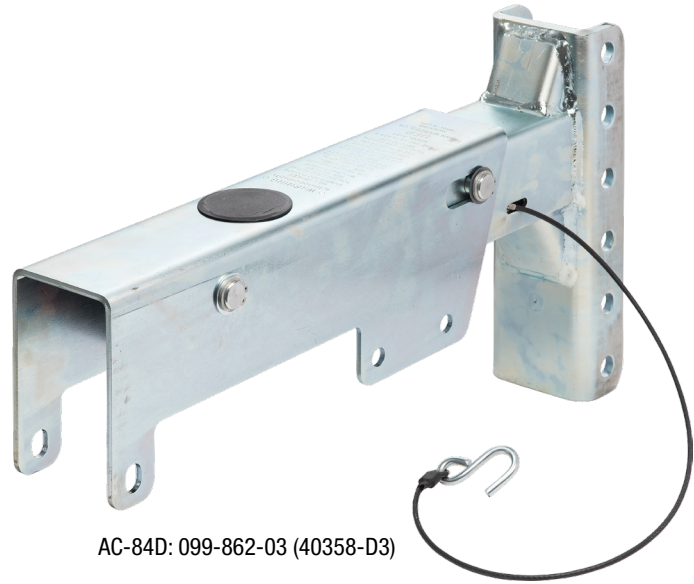

AC-84D: 099-862-03 (40358-D3)

DRUM BRAKE

DX # (UFP#)	Channel	Placement	Description
099-840-00 (40301)	4 Hole	Center	AC-84: Inner Member, Drum
099-842-00 (40359)	4 Hole	Down	
099-860-00 (40360)	6 Hole	Center	
099-862-00 (40358)	6 Hole	Down	
099-840-01 (40247)	4 Hole	Center	AC-84XL: Drum, Primed, Weld On, 19" Long (3" x 3" or 3" x 4" Straight Tongue)
099-842-01 (40406)	4 Hole	Down	
099-860-01 (40405)	6 Hole	Center	
099-862-01 (40407)	6 Hole	Down	
099-840-03 (40191-D3)	4 Hole	Center	AC-84D: Drum, Zinc, Bolt On, D3 Bracket
099-842-03 (40359-D3)	4 Hole	Down	
099-860-03 (40360-D3)	6 Hole	Center	
099-862-03 (40358-D3)	6 Hole	Down	
099-840-05 (40195-T)	4 Hole	Center	AC-84T: Drum, Zinc, Bolt On, T Bracket
099-842-05 (40359-T)	4 Hole	Down	
099-860-05 (40360-T)	6 Hole	Center	
099-862-05 (40358-T)	6 Hole	Down	

Dexter Part Number Key

DX #: 099 - 862 - 03

INNER MEMBER: AC-84		
Number	Channel	Placement
840	4 Hole	Center
842	4 Hole	Down
860	6 Hole	Center
862	6 Hole	Down

SINGLE / TANDEM DISC BRAKE

DX # (UFP#)	Channel	Placement	Description
099-840-20 (40303)	4 Hole	Center	AC-84: Inner Member, Disc w/ Solenoid
099-842-20 (40408)	4 Hole	Down	
099-860-20 (40390)	6 Hole	Center	
099-862-20 (40409)	6 Hole	Down	
099-840-21 (40248)	4 Hole	Center	AC-84XL: Disc, Primed, Weld On, 19" Long
099-842-21 (40411)	4 Hole	Down	(3" x 3" or 3" x 4" Straight Tongue)
099-860-21 (40410)	6 Hole	Center	
099-862-21 (40412)	6 Hole	Down	
099-840-23 (40193-D3)	4 Hole	Center	AC-84D: Disc, Zinc, Bolt On, D3 Bracket
099-842-23 (40408-D3)	4 Hole	Down	
099-860-23 (40390-D3)	6 Hole	Center	
099-862-23 (40409-D3)	6 Hole	Down	
099-840-25 (40197-T)	4 Hole	Center	AC-84T: Disc, Zinc, Bolt On, T Bracket
099-842-25 (40408-T)	4 Hole	Down	
099-860-25 (40390-T)	6 Hole	Center	
099-862-25 (40409-T)	6 Hole	Down	

TRIPLE DISC BRAKE

DX # (UFP#)	Channel	Placement	Description
099-840-30 (40304)	4 Hole	Center	AC-84: Inner Member, Triple Disc w/ Solenoid
099-842-30 (40413)	4 Hole	Down	
099-860-30 (40415)	6 Hole	Center	
099-862-30 (40414)	6 Hole	Down	
099-840-31 (40249)	4 Hole	Center	AC-84XL: Triple Disc, Primed, Weld On, 19" Long (3" x 3" or 3" x 4" Straight Tongue)
099-842-31 (40417)	4 Hole	Down	
099-860-31 (40416)	6 Hole	Center	
099-862-31 (40418)	6 Hole	Down	
099-840-33 (40194-D3)	4 Hole	Center	AC-84D: Triple Disc, Zinc, Bolt On, D3 Bracket
099-842-33 (40413-D3)	4 Hole	Down	
099-860-33 (40415-D3)	6 Hole	Center	
099-862-33 (40414-D3)	6 Hole	Down	
099-840-35 (40198-T)	4 Hole	Center	AC-84T: Triple Disc, Zinc, Bolt On, T Bracket
099-842-35 (40413-T)	4 Hole	Down	
099-860-35 (40415-T)	6 Hole	Center	
099-862-35 (40414-T)	6 Hole	Down	

Dexter Part Number Key

DX #: 099-862-0 3

OUTER MEMBER: AC-84	
Number	Model
0	No outer member
1	"XL" Primed weld on housing, 19" long for 3" x 3" or 3" x 4" straight tongue
3	"D3" Zinc bolt on housing, Demco 3 hole
5	"T5" Zinc bolt on housing, Titan 5 hole

A-160: 16,000 LB, 2 5/16" BALL

FEATURES

The A-160 actuator features a robust cast coupling in straight or drop configurations.

The sleek square nose design pioneered a new cosmetic look in the actuator marketplace.

The unique over-center latch mechanism will only engage when the actuator is fully seated on the ball.

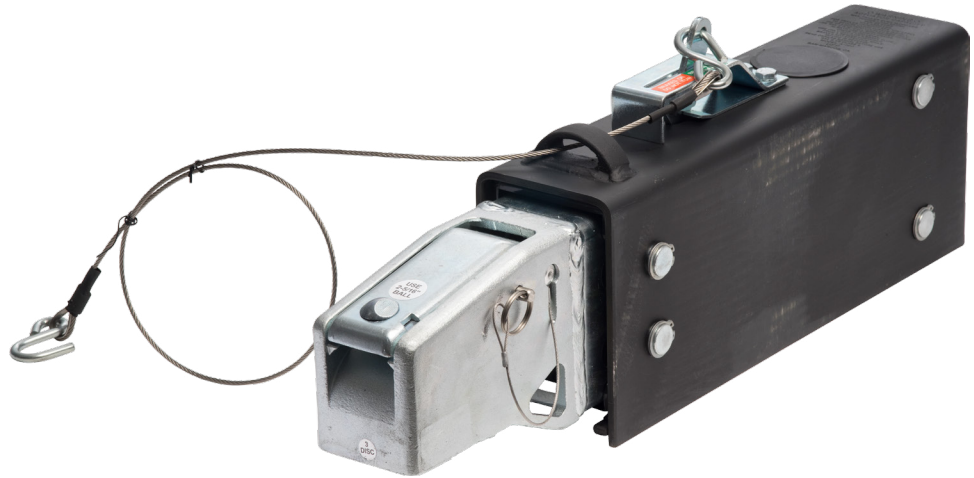

A-160: 099-160-01 (40030)

DRUM BRAKE

DX # (UFP#)	Angle	Description
099-160-01 (40030)	Straight	A-160: Drum, Primed, Weld On 16"
099-162-01 (40033)	Drop	
099-160-02 (40136)	Straight	A-160: Drum, Primed, Weld On, In Line
099-160-03 (40020)	Straight	A-160: Drum, Zinc, Bolt On, In Line
099-160-04 (40070)	Straight	A-160: Drum, Zinc, Bolt On
099-162-04 (40073)	Drop	
099-160-05 (40070-D)	Straight	A-160: Drum, Zinc, Bolt On, D Bracket
099-162-05 (70073-D)	Drop	
099-160-06 (40070-D3)	Straight	A-160: Drum, Zinc, Bolt On, D3 Bracket
099-162-06 (40073-D3)	Drop	
099-160-09	Straight	A-160: Drum, Primed, Weld On 20"
099-162-09	Drop	
099-160-0A	Straight	A-160: Drum, Zinc, Bolt On, T bracket
099-162-0A	Drop	

Dexter Part Number Key

DX #: 099-160-0 1

OUTER MEMBER: A-160	
Number	Model
1	Weld on 16", primed
2	In line, weld on 26", primed
3	In line, bolt on, zinc
4	Bolt on, zinc, standard
5	Bolt on, zinc, D bracket
6	Bolt on, zinc, D3 bracket
9	Weld on 20", primed
A	Bolt on, zinc, T bracket

FEATURES

The A-160 actuator features a robust cast coupling in straight or drop configurations.

The sleek square nose design pioneered a new cosmetic look in the actuator marketplace.

The unique over-center latch mechanism will only engage when the actuator is fully seated on the ball.

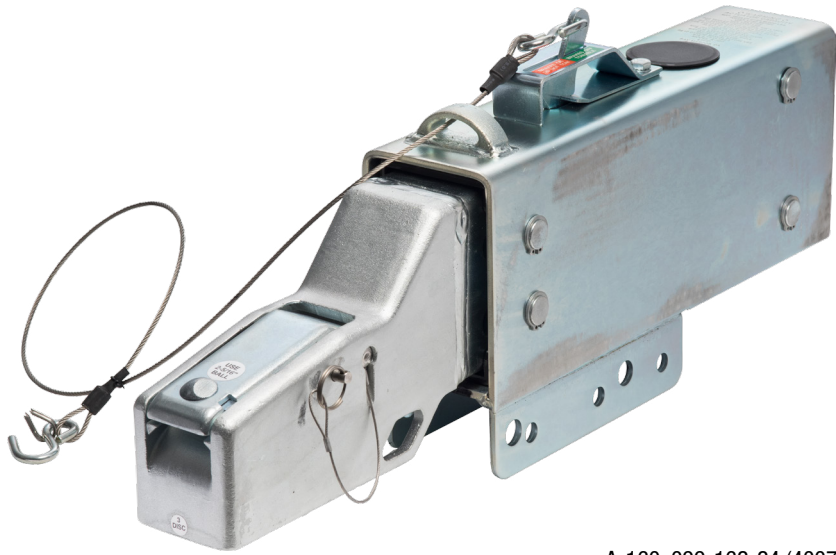

A-160: 099-162-24 (40074)

A-160: 16,000 LB, 2 5/16" BALL

SINGLE / TANDEM DISC BRAKE

DX # (UFP#)	Angle	Description
099-160-21 (40031)	Straight	A-160: Disc, Primed, Weld On 16"
099-162-21 (40034)	Drop	
099-160-22 (40137)	Straight	A-160: Disc, Primed, Weld On, In Line
099-160-23 (40021)	Straight	A-160: Disc, Zinc, Bolt On, In Line
099-160-24 (40071)	Straight	A-160: Disc, Zinc, Bolt On
099-162-24 (40074)	Drop	
099-160-25 (40071-D)	Straight	A-160: Disc, Zinc, Bolt On, D Bracket
099-162-25 (70074-D)	Drop	
099-160-26 (40071-D3)	Straight	A-160: Disc, Zinc, Bolt On, D3 Bracket
099-162-26 (40074-D3)	Drop	
099-160-29	Straight	A-160: Disc, Primed, Weld On 20"
099-162-29	Drop	
099-160-2A	Straight	A-160: Disc, Zinc, Bolt On, T bracket
099-162-2A	Drop	

TRIPLE DISC BRAKE

DX # (UFP#)	Angle	Description
099-160-31 (40032)	Straight	A-160: Triple Disc, Primed, Weld On
099-162-31 (40035)	Drop	
099-160-32 (40138)	Straight	A-160: Triple Disc, Primed, Weld On, In Line
099-160-33 (40022)	Straight	A-160: Triple Disc, Zinc, Bolt On, In Line
099-160-34 (40072)	Straight	A-160: Triple Disc, Zinc, Bolt On
099-162-34 (40075)	Drop	
099-160-35 (40072-D)	Straight	A-160: Triple Disc, Zinc, Bolt On, D Bracket
099-162-35 (70075-D)	Drop	
099-160-36 (40072-D3)	Straight	A-160: Triple Disc, Zinc, Bolt On, D3 Bracket
099-162-36 (40086-D3)	Drop	
099-160-39	Straight	A-160: Triple Disc, Primed, Weld On 20"
099-162-39	Drop	
099-160-3A	Straight	A-160: Triple Disc, Zinc, Bolt On, T bracket
099-162-3A	Drop	

FEATURES

The A-200 actuator offers an adjustable channel front allowing a variety of bolt on attachments and mounting heights.

Covers capacity needs for 10k, 12k, or 20k at a competitive price point.

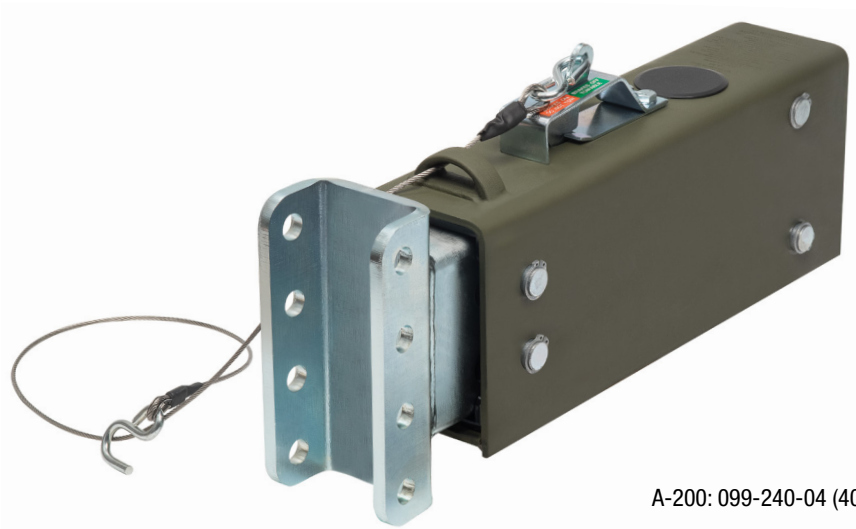

A-200: 099-240-04 (40274)

DRUM BRAKE

DX # (UFP#)	Channel	Placement	Description
099-240-01 (40270)	4 Hole	Center	A-200: Drum, Zinc, Bolt On
099-242-01 (40276)	4 Hole	Down	
099-260-01 (40271)	6 Hole	Center	
099-262-01 (40277)	6 Hole	Down	
099-240-02 (40270-D)	4 Hole	Center	A-200: Drum, Zinc, Bolt On, D Bracket
099-242-02 (40276-D)	4 Hole	Down	
099-260-02 (40271-D)	6 Hole	Center	
099-262-02 (40277-D)	6 Hole	Down	
099-240-03 (40270-D3)	4 Hole	Center	A-200: Drum, Zinc, Bolt On, D3 Bracket
099-242-03 (40276-D3)	4 Hole	Down	
099-260-03 (40271-D3)	6 Hole	Center	
099-262-03 (40277-D3)	6 Hole	Down	
099-240-04 (40274)	4 Hole	Center	A-200: Drum, Primed, Weld On 16"
099-242-04 (40280)	4 Hole	Down	
099-260-04 (40275)	6 Hole	Center	
099-262-04 (40281)	6 Hole	Down	
099-240-05	4 Hole	Center	A-200: Drum, Primed, Weld On 20"
099-242-05	4 Hole	Down	
099-260-05	6 Hole	Center	
099-262-05	6 Hole	Down	
099-240-06	4 Hole	Center	A-200: Drum, Zinc, Bolt On, T Bracket
099-242-06	4 Hole	Down	
099-260-06	6 Hole	Center	
099-262-06	6 Hole	Down	

Dexter Part Number Key

DX #: 099 - **240** - 04

INNER MEMBER: A-200		
Number	Channel	Placement
240	4 Hole	Center
242	4 Hole	Down
260	6 Hole	Center
262	6 Hole	Down

FEATURES

The A-200 actuator offers an adjustable channel front allowing a variety of bolt on attachments and mounting heights.

Covers capacity needs for 10k, 12k, or 20k at a competitive price point.

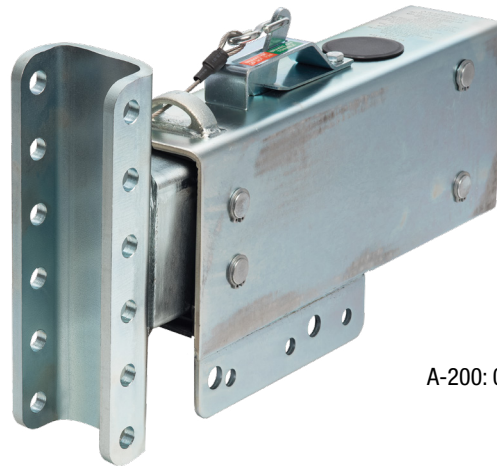

A-200: 099-260-31 (40371)

A-200: 20,000 LB, ADJUSTABLE CHANNEL

DISC BRAKE

DX # (UFP#)	Channel	Placement	Description
099-240-31 (40370)	4 Hole	Center	A-200: Disc, Zinc, Bolt On
099-242-31 (40376)	4 Hole	Down	
099-260-31 (40371)	6 Hole	Center	
099-262-31 (40377)	6 Hole	Down	
099-240-32 (40370-D)	4 Hole	Center	A-200: Disc, Zinc, Bolt On, D Bracket
099-242-32 (40376-D)	4 Hole	Down	
099-260-32 (40371-D)	6 Hole	Center	
099-262-32 (40377-D)	6 Hole	Down	
099-240-33 (40370-D3)	4 Hole	Center	A-200: Disc, Zinc, Bolt On, D3 Bracket
099-242-33 (40376-D3)	4 Hole	Down	
099-260-33 (40371-D3)	6 Hole	Center	
099-262-33 (40377-D3)	6 Hole	Down	
099-240-34 (40374)	4 Hole	Center	A-200: Disc, Primed, Weld On 16"
099-242-34 (40380)	4 Hole	Down	
099-260-34 (40375)	6 Hole	Center	
099-262-34 (40381)	6 Hole	Down	
099-240-35	4 Hole	Center	A-200: Disc, Primed, Weld On 20"
099-242-35	4 Hole	Down	
099-260-35	6 Hole	Center	
099-262-35	6 Hole	Down	
099-240-36	4 Hole	Center	A-200: Disc, Zinc, Bolt On, T Bracket
099-242-36	4 Hole	Down	
099-260-36	6 Hole	Center	
099-262-36	6 Hole	Down	

Dexter Part Number Key

DX #: 099-260-3 [1]

OUTER MEMBER: A-200	
Number	Model
1	Bolt on, zinc
2	Bolt on, zinc, D bracket
3	Bolt on, zinc D3 bracket
4	Weld on 16", primed
5	Weld on 20", primed
6	Bolt on, zinc, T bracket



K71-755-00

Solenoid Replacement Kit (All Models)

Qty	Description
1	Solenoid
2	Black Nylon Cable Tie
1	Drain Tube



K71-756-00

Master Cylinder Replacement Kit - Drum (All Models)

Qty	Description
1	Master Cylinder - Drum

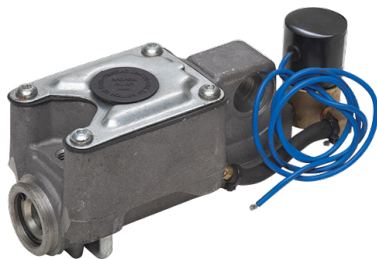

K71-757-00

Master Cylinder Replacement Kit - Disc (All Models)

Qty	Description
1	Master Cylinder - Disc



K71-758-00

Shock Absorber Replacement Kit (A-60, A-75, A-84, AC-84, XR-84)

Qty	Description
1	Shock Absorber
1	Bushing, Shock
1	Bolt

K71-759-00

Roller Pin and Pad Kit (A-60, A-75, A-84, AC-84, XR-84)



Qty	Description
2	Pin, Roller, Zinc
2	Roller Pin Washer, Metal, Rear
2	Roller Pin Washer, Nylon, Front
4	Retaining Ring
2	Roller, Rear
2	Roller, Front (A-60)
1	Wear Pad, Top (A-60)
2	Wear Pad, Top (A-75, A-84, AC-84, XR-84)
6	Wear Pad, Side, Thin
3	Wear Pad, Top/Bottom, Thick

K71-760-00

Emergency Cable Replacement Kit (A-60)

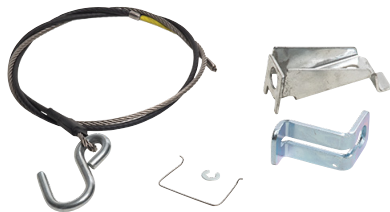

Qty	Description
1	Breakaway Cable, A-60
1	Cable Attachment Plate
1	Breakaway Cable Clip
1	Pushrod Release Bracket
1	Pushrod Release Bracket Spring

K71-761-00

Emergency Cable Replacement Kit (A-75)

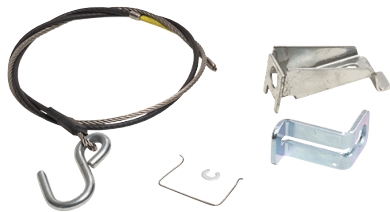

Qty	Description
1	Breakaway Cable, A-75
1	Cable Attachment Plate
1	Breakaway Cable Clip
1	Pushrod Release Bracket
1	Pushrod Release Bracket Spring

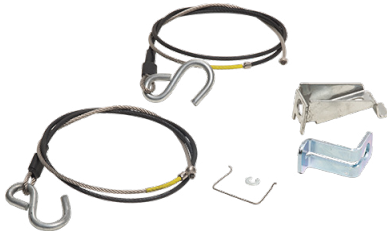

K71-762-00

Emergency Cable Replacement Kit (A-84)

Qty	Description
1	Breakaway Cable, (Old - Front Exit)
1	Breakaway Cable, (New - Side Exit)
1	Cable Attachment Plate
1	Pushrod Release Bracket
1	Pushrod Release Bracket Spring

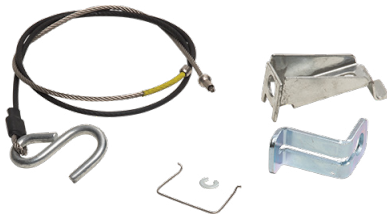

K71-763-00

Emergency Cable Replacement Kit (AC-84, XR-84)

Qty	Description
1	Breakaway Cable, XR-84, A-84, A-75HD (New - Side Exit)
1	Cable Attachment Plate
1	Pushrod Release Bracket
1	Pushrod Release Bracket Spring



K71-764-00

Hitch Pin Kit (A-60)

Qty	Description
1	Long Hitch Pin Kit, A-60



K71-765-00

Hitch Pin Kit (A-75)

Qty	Description
1	Short Hitch Pin Kit, A-75



K71-766-00

Latch Replacement Kit (A-75)

Qty	Description
1	Latch Replacement Kit, A-75



K71-767-00

Hitch Pin Kit (A-84, XR-84, A-160)

Qty	Description
1	Hitch Pin Kit, A-84, XR-84, A-160



K71-768-00

Latch Replacement Kit (A-84, A-160)

Qty	Description
1	Latch Replacement Kit, A-84, A-160

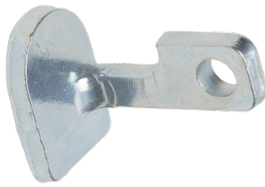

K71-769-00

Consumer Lockout Kit (A-60, A-75, A-84, AC-84, XR-84)

Qty	Description
1	Consumer Lockout Kit, A-60, A-75, A-84, AC-84, XR-84

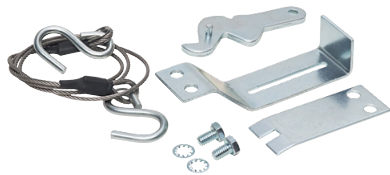

K71-770-00

Emergency Cable Replacement Kit (A-160, A-200)

Qty	Description
1	Breakaway Lever Kit, A-160, A-200



K71-771-00

Shock Absorber Replacement Kit (A-160, A-200)

Qty	Description
2	Shock Absorber
1	Pin, Shock, Front



K71-772-00

Roller Pin and Pad Kit (A-160, A-200)

Qty	Description
1	Latch Handle Replacement Kit, A-160
2	Spacer Bushing
4	Roller Pin
8	Retainer Ring
2	Slide Bearing

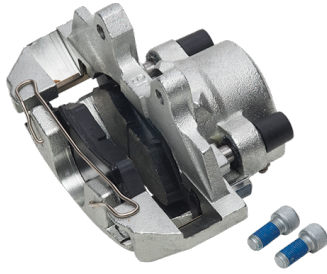

K71-773-01

Caliper Replacement Kit - LH (DB35), (3.5K - 7K)

Qty	Description
1	Caliper Assembly - LH, Zinc
2	Bolt with Threadlock Coating

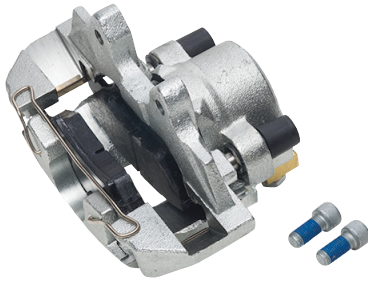

K71-773-02

Caliper Replacement Kit - RH (DB35), (3.5K - 7K)

Qty	Description
1	Caliper Assembly - RH, Zinc
2	Bolt with Threadlock Coating

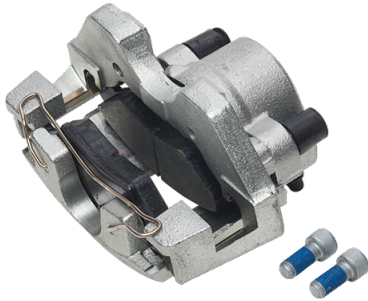

K71-774-01

Caliper Replacement Kit - LH (Special 8" Disc)

Qty	Description
1	Caliper Assembly - LH, Zinc
2	Bolt with Threadlock Coating

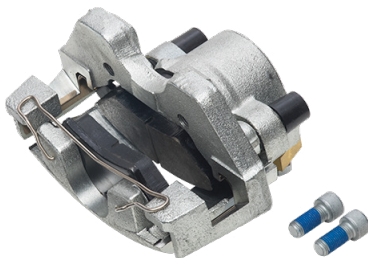

K71-774-02

Caliper Replacement Kit - RH (Special 8" Disc)

Qty	Description
1	Caliper Assembly - RH, Zinc
2	Bolt with Threadlock Coating

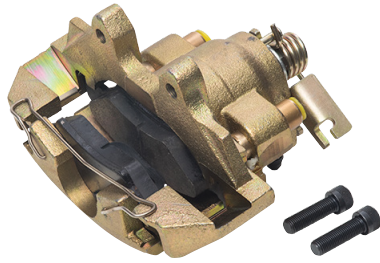

K71-775-01

Caliper Replacement Kit - LH (Special Parking Brake), 3.5K - 7K, Zinc

Qty	Description
1	Caliper Assembly - LH, Parking Brake Lever
2	Bolt with Threadlock Coating

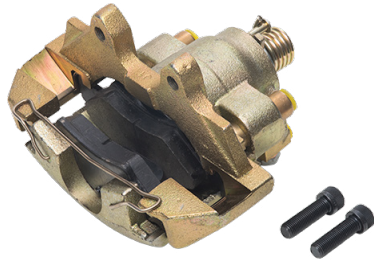

K71-775-02

Caliper Replacement Kit - RH (Special Parking Brake), 3.5K - 7K, Zinc

Qty	Description
1	Caliper Assembly - RH, Parking Brake Lever
2	Bolt with Threadlock Coating

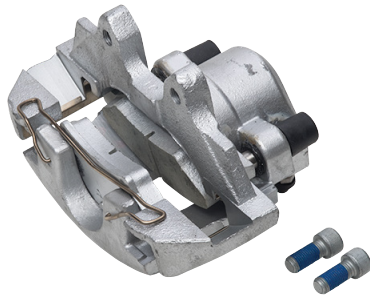

K71-776-01

Caliper Replacement Kit - LH (DB35), 3.5K - 7K, Aluminum

Qty	Description
1	Caliper Assembly - LH, Aluminum
2	Bolt with Threadlock Coating

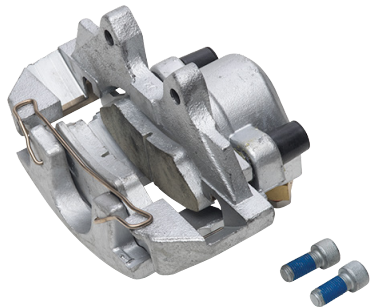

K71-776-02

Caliper Replacement Kit - RH (DB35), 3.5K - 7K, Aluminum

Qty	Description
1	Caliper Assembly - RH, Aluminum
2	Bolt with Threadlock Coating

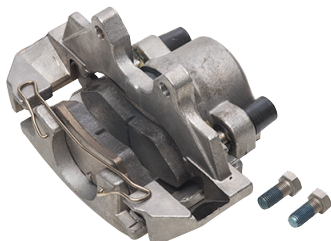

K71-777-01

Caliper Replacement Kit - LH (DB35), 3.5K - 7K, Stainless Steel

Qty	Description
1	Caliper Assembly - LH, Stainless Steel
2	Bolt with Threadlock Coating, Stainless Steel

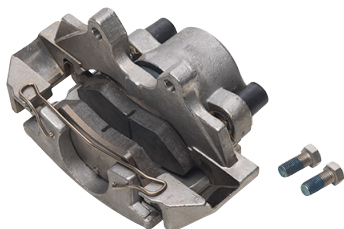

K71-777-02

Caliper Replacement Kit - RH (DB35), 3.5K - 7K, Stainless Steel

Qty	Description
1	Caliper Assembly - RH, Stainless Steel
2	Bolt with Threadlock Coating, Stainless Steel



K71-778-01

Caliper Replacement Kit - LH (DB42), Old Style - Prior to 2005

Qty	Description
1	Caliper Assembly - LH, DB42
1	Set of Pads, DB42 (1 inner and 1 outer)
1	Bolt
1	Retainer, Clamp
2	Spring Clip



K71-778-02

Caliper Replacement Kit - RH (DB42), Old Style - Prior to 2005

Qty	Description
1	Caliper Assembly - RH, DB42
1	Set of Pads, DB42 (1 inner and 1 outer)
1	Bolt
1	Retainer, Clamp
2	Spring Clip

K71-779-00

Caliper Replacement Kit (DB35), Freshwater, For One Axle



Qty	Description
4	Universal Brake Pad, Inner/Outer, DB35
4	Seat, Pad, Stainless Steel
2	Retainer, Wire-form
2	Boot, Dust
2	Piston Seal
4	Boot, Slider Pin Bolt
4	Plug, Slider Pin Bolt
4	Bolt with Threadlock Coating

K71-780-00

Caliper Replacement Kit (DB35), Saltwater, For One Axle



Qty	Description
4	Universal Brake Pad, Inner/Outer, Stainless Steel, DB35
4	Seat, Pad
2	Retainer, Wire-form
2	Boot, Dust
2	Piston Seal
4	Boot, Slider Pin Bolt
4	Plug, Slider Pin Bolt
4	Bolt with Threadlock Coating, Stainless Steel

K71-781-00

Caliper Replacement Kit (DB42), Old Style, For One Axle



Qty	Description
2	Set of Pads, DB42 (1 inner and 1 outer)
2	Bolt
2	Retainer, Clamp
4	Spring Clip
2	Slider Boot Pin Bolt
2	Dust Boot
2	Piston Seal



K71-027-00

Vault Service Kit: 7K 865 - 2.717"

Qty	Description
2	O-ring
2	Trailer Buddy Assembly, Vault
1	Vault Lube Tube
1	Vault Installation Tool
1	Loctite
1	Grease Fitting



K71-028-00

Vault Service Kit: 6K 655 - 2.441"

Qty	Description
2	O-ring
2	Trailer Buddy Assembly, Vault
1	Vault Lube Tube
1	Vault Installation Tool
1	Loctite
1	Grease Fitting



K71-029-00

Vault Service Kit: 4.2K 545 and 5.2K 655 - 2.328"

Qty	Description
2	O-ring
2	Trailer Buddy Assembly, Vault
1	Vault Lube Tube
1	Vault Installation Tool
1	Loctite
1	Grease Fitting



K71-030-00

Vault Service Kit: 2.5K, 3.2K, and 3.5K 545 - 1.980"

Qty	Description
2	O-ring
2	Trailer Buddy Assembly, Vault
1	Vault Lube Tube
1	Vault Installation Tool
1	Loctite
1	Grease Fitting



K71-031-00

Stainless Steel Protector / Bra Kit: 7K 865 - 2.717", Outer Bore

Qty	Description
2	Stainless Steel Protector
2	Bra, 23B



K71-032-00

Stainless Steel Protector / Bra Kit: 6K 655 - 2.441", Outer Bore

Qty	Description
2	Stainless Steel Protector
2	Bra, 23B



K71-033-00

Stainless Steel Protector / Bra Kit: 4.2K 545 and 5.2K 655 - 2.328", Outer Bore

Qty	Description
2	Stainless Steel Protector
2	Bra, 23B



K71-034-00

Stainless Steel Protector / Bra Kit: 2.1K, 2.5K, 3.2K, and 3.5K 545 - 1.980", Outer Bore

Qty	Description
2	Stainless Steel Protector
2	Bra, 19B



K71-035-00

Trailer Buddy "Special": UFP OEM Axles Only - 1.980", Outer Bore

Qty	Description
2	Trailer Buddy Protector
2	Trailer Buddy Stainless Cap



K71-006-00 (7241)
Stainless Steel Protector Kit 1781A

Qty	Description
2	Stainless Steel Protector, fits 1.781" outer bore



K71-008-00 (7245)
Stainless Steel Protector Kit 1938A

Qty	Description
2	Stainless Steel Protector, fits 1.938" outer bore



K71-009-00 (7247)
Stainless Steel Protector Kit 1968A

Qty	Description
2	Stainless Steel Protector, fits 1.968" outer bore



K71-010-00 (7251)
Stainless Steel Protector Kit 2047A

Qty	Description
2	Stainless Steel Protector, fits 2.047" outer bore



K71-012-00 (7255)
Stainless Steel Protector Kit 2240A

Qty	Description
2	Stainless Steel Protector, fits 2.240" outer bore



K71-013-00 (7257)
Stainless Steel Protector Kit 2328A

Qty	Description
2	Stainless Steel Protector, fits 2.328" outer bore



K71-001-00 (7371)
Stainless Steel Protector Kit 1980A

Qty	Description
2	Stainless Steel Protector, fits 1.980" outer bore



K71-016-00 (7651)
Stainless Steel Protector Kit 1980TA

Qty	Description
2	Stainless Steel Protector (Threaded), fits 1.980" outer bore



K71-002-00 (7656)
Stainless Steel Protector Kit 2441A

Qty	Description
2	Stainless Steel Protector, fits 2.441" outer bore



K71-005-00 (7671)
Stainless Steel Protector Kit 2717A

Qty	Description
2	Stainless Steel Protector, fits 2.717" outer bore



K71-036-00

Stainless Steel Protector, Oil Bath, 3.7K - 1.980" Outer Bore

Qty	Description
2	O-ring
2	Trailer Buddy Assembly
1	Loctite



K71-037-00

Stainless Steel Protector, Oil Bath, 4.2K and 5.2K - 2.328" Outer Bore

Qty	Description
2	O-ring
2	Trailer Buddy Assembly
1	Loctite



K71-017-00 (5680)

Protector Bra Kit, 19B

Qty	Description
2	Bra

Fits SS Protector Kits: 1980A, 1980TA, 1938A, 1968A, 2047A



K71-018-00 (5681)

Protector Bra Kit, 17B

Qty	Description
2	Bra

Fits SS Protector Kits: 1791A



K71-019-00 (5682)

Protector Bra Kit, 23B

Qty	Description
2	Bra

Fits SS Protector Kits: 2328A, 2441A, 2717A, 2240A

K71-040-00

Stud Kit: Standard UFP Integral Hub/Rotors and Hubs, 1/2" - 20



Qty	Description
-----	-------------

5 Stud, Press-fit, Short

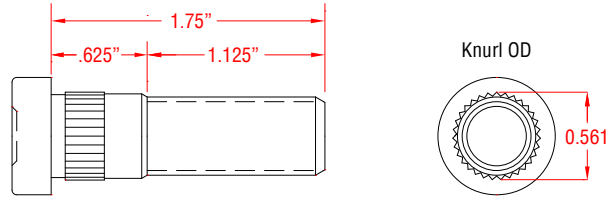

K71-041-00

Stud Kit: Two Piece Rotor Rear Mount, 1/2" - 20



Qty	Description
-----	-------------

5 Stud, Press-fit, Long, Old Two Piece Rotor

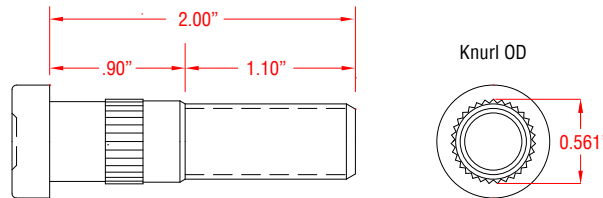

K71-042-00

Stud Kit: Two Piece Rotor Front Hat Mount, 1/2" - 20



Qty	Description
-----	-------------

5 Stud, Press-fit, Long, New Two Piece Rotors/Hats

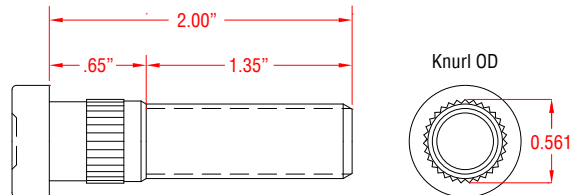



K71-043-00

Bearing and Seal Replacement Kit: 7K 865, 2.717" Outer Bore

Qty	Description
2	Seal
2	25520 Inner Race
2	25580 Inner Bearing
2	15245 Outer Race
2	15123 Outer Bearing
2	Cotter Pin



K71-044-00

Bearing and Seal Replacement Kit: 6K 655, 2.441" Outer Bore

Qty	Description
2	Seal
2	25520 Inner Race
2	25580 Inner Bearing
2	14276 Outer Race
2	14125A Outer Bearing
2	Cotter Pin



K71-055-00

Bearing and Seal Replacement Kit: 5.2K 655, 2.328" Outer Bore

Qty	Description
2	Seal
2	25520 Inner Race
2	25580 Inner Bearing
2	LM67010 Outer Race
2	LM67048 Outer Bearing
2	Cotter Pin



K71-058-00

Bearing and Seal Replacement Kit: 4.2K 545, 2.328" Outer Bore

Qty	Description
2	2.56 x 1.68 Seal for New Axles
2	2.33 x 1.68 Seal for Older Axles
2	L68110 Inner Race
2	L68149 Inner Bearing
2	L68110 Outer Race
2	L68149 Outer Bearing
2	Cotter Pin



K71-059-00

Bearing and Seal Replacement Kit: 3.2 and 3.7K 545, 1.980" Outer Bore

Qty	Description
2	2.56 x 1.68 Seal for New Axles
2	2.33 x 1.68 Seal for Older Axles
2	L68110 Inner Race
2	L68111 Inner Race for Newer Hubs
2	L68149 Inner Bearing
2	L44610 Outer Race for Older Hubs
2	L44649 Outer Bearing
2	Cotter Pin



K71-060-00

Bearing and Seal Replacement Kit: 2.1K and 2.5K 545, 1.980" Outer Bore

Qty	Description
2	1.98 x 1.38 Seal for Older Axles
2	1.98 x 1.25 Seal for New Axles
4	L44610 Inner and Outer Race
4	L44649 Inner and Outer Bearing
2	Cotter Pin



K71-788-00 (7002)

Bearing Kit for 1" Spindle

Qty	Description
2	LL44643 Cone
2	L44610 Cup
1	Cotter Pin



K71-789-00 (7003)

Bearing Kit for 1 1/16" Spindle

Qty	Description
2	LL44649 Cone
2	L44610 Cup
1	Cotter Pin



K71-790-00 (7004)

Bearing Kit for 1 1/4" Spindle

Qty	Description
2	LM67048 Cone
2	LM67010 Cup
1	Cotter Pin



K71-791-00 (7005)

Bearing Kit for 1 1/16" - 3/4" Spindle

Qty	Description
1	L44649 Cone
1	L44610 Cup
1	LM11949 Cone
1	LM11910 Cup
1	Cotter Pin



K71-792-00 (7007)

Bearing Kit for 1 3/8" - 1 1/16" Spindle

Qty	Description
1	L68149 Cone
1	L68110 Cup
1	L44649 Cone
1	L44610 Cup
1	Cotter Pin



K71-793-00 (7008)

Bearing Kit for 1 3/8" - 1 1/16" Spindle

Qty	Description
1	L68149 Cone
1	L68111 Cup
1	L44649 Cone
1	L44610 Cup
1	Cotter Pin



K71-794-00 (7009)

Bearing Kit for 1 3/4" - 1 1/4" Spindle

Qty	Description
1	25580 Cone
1	25520 Cup
1	LM67048 Cone
1	LM62010 Cup
1	Cotter Pin



K71-795-00 (7010)

Bearing Kit for 1 3/4" - 1 1/4" Spindle

Qty	Description
1	25580 Cone
1	25520 Cup
1	14125A Cone
1	14276A Cup
1	Cotter Pin



K71-796-00 (7011)

Bearing Kit for 1 3/8" - 1 3/8" Spindle

Qty	Description
2	L68149 Cone
2	L68110 Cup
1	Cotter Pin



K71-782-00 (5611)

Spindo Seal #1 Kit

Qty	Description
2	O-ring
2	Stainless Steel Wear Ring
2	Seals



K71-783-00 (5613)

Spindo Seal #2 Kit

Qty	Description
2	O-ring
2	Stainless Steel Wear Ring
2	Seals



K71-784-00 (5631)

Spindo Seal #11 Kit

Qty	Description
2	O-ring
2	Stainless Steel Wear Ring
2	Seals



K71-797-00 (7022)

Seal Kit: 1.98" OD x 1.25" ID

Qty	Description
2	Seals



K71-798-00 (7023)

Seal Kit: 1.98" OD x 1.50" ID

Qty	Description
2	Seals



K71-799-00 (7024)

Seal Kit: 2.33" OD x 1.50" ID

Qty	Description
2	Seals

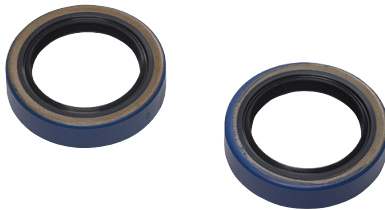

K71-800-00 (7026)

Seal Kit: 1.98" OD x 1.38" ID

Qty	Description
2	Seals



K71-801-00 (7027)

Seal Kit: 2.33" OD x 1.68" ID

Qty	Description
2	Seals



K71-802-00 (7028)

Seal Kit: 2.56" OD x 1.68" ID

Qty	Description
2	Seals



K71-803-00 (7029)

Seal Kit: 3.26" OD x 2.13" ID

Qty	Description
2	Seals



K71-062-00

Spindle Hardware Kit: 5.2K - 7K Spindles

Qty	Description
2	O-Ring
2	Stainless Steel Seal Wear Ring
2	D Washer
2	Spindle Nut
2	Nut Retainer
2	Cotter Pin

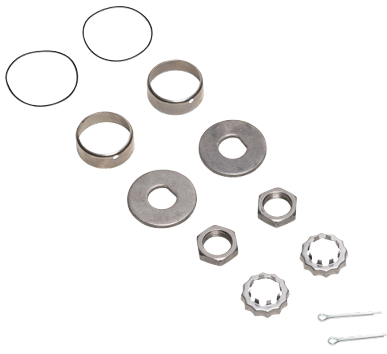

K71-063-00

Spindle Hardware Kit: 4.2K Spindles

Qty	Description
2	O-Ring
2	Stainless Steel Seal Wear Ring
2	D Washer
2	Spindle Nut
2	Nut Retainer
2	Cotter Pin



K71-064-00

Spindle Hardware Kit: 3.2K and 3.7K Spindles

Qty	Description
2	O-Ring
2	Stainless Steel Wear Ring
2	D Washer
2	Spindle Nut
2	Nut Retainer
2	Cotter Pin

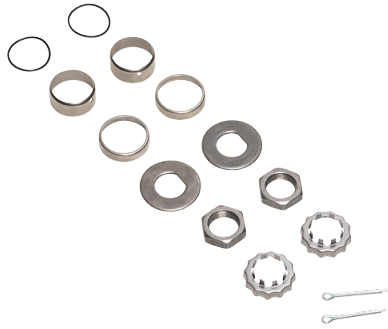

K71-065-00

Spindle Hardware Kit: 2.5K Spindles

Qty	Description
2	O-Ring
2	1.25" Stainless Steel Wear Ring
2	1.38" Stainless Steel Wear Ring
2	D Washer
2	Spindle Nut
2	Nut Retainer
2	Cotter Pin



K71-066-00

Spindle Hardware Kit: 2.1K and 2.3K Spindles

Qty	Description
2	Cotter Pin
2	Nut Retainer
2	Spindle Nut
2	"D" Washer
2	Stainless Steel Seal Wear Ring



K71-067-00

Torsion Trailing Arm and Hardware Kit: 3.7K for Idler, Disc or Drum

Qty	Description
1	Torsion Arm and Spindle, Zinc
1	Bolt
1	Nut, Lock
1	Washer, Flat
1	Cotter Pin
1	2.56" x 1.68" Seal for New Axles
1	2.33" x 1.68" Seal for Older Axles



K71-068-00

Torsion Trailing Arm and Hardware Kit: 4.2K for Idler or Disc

Qty	Description
1	Torsion Arm and Spindle, Zinc
1	Bolt
1	Nut, Lock
1	Washer, Flat
1	Cotter Pin
1	2.56" x 1.68" Seal for New Axles
1	2.33" x 1.68" Seal for Older Axles



K71-069-00

Torsion Trailing Arm and Hardware Kit: 5.2K - 7K for Idler or Disc

Qty	Description
1	Torsion Arm and Spindle, Zinc
1	Bolt
1	Nut, Lock
1	Washer, Flat
1	Cotter Pin
1	Seal



K71-070-00

Complete Torsion Arm Kit: 3.7K 545 Zinc Hub with Vault

Qty	Description
1	Torsion Arm Assembly
1	Bolt
1	Nut
1	Washer



K71-071-00

Complete Torsion Arm Kit: 3.7K 545 Zinc Hub and Rotor with Vault

Qty	Description
1	Torsion Arm Assembly
1	Bolt
1	Nut
1	Washer

K08-439-05

Single Boxed Hub and Rotor: 7K 865,
Cupped and Studded, Zinc (DB35)



Compatible with:

- K71-773-01: Caliper Assy Kit - LH - Zinc
- K71-773-02: Caliper Assy Kit - RH - Zinc
- K71-776-01: Caliper Assy Kit - LH - Aluminum
- K71-776-02: Caliper Assy Kit - RH - Aluminum
- K71-779-00: Pad Replacement Kit (DB 35) - Freshwater - One Axle
- K71-780-00: Pad Replacement Kit (DB 35) - Saltwater - One Axle
- K71-027-00: Vault Service Kit - 7K 865 - 2.717" Outer Bore
- K71-031-00: Trailer Buddy SS Protector & Bra Kit - 2.717" Outer Bore
- K71-043-00: Bearing & Seal Replacement Kit - 2.717" Outer Bore
- K71-062-00: Spindle Hardware Kit - 5.2K Thru 7K Spindles

K08-441-05

Single Boxed Hub and Rotor: 5.2K 655,
Cupped and Studded, Zinc (DB35)



Compatible with:

- K71-773-01: Caliper Assy Kit - LH - Zinc
- K71-773-02: Caliper Assy Kit - RH - Zinc
- K71-776-01: Caliper Assy Kit - LH - Aluminum
- K71-776-02: Caliper Assy Kit - RH - Aluminum
- K71-779-00: Pad Replacement Kit (DB 35) - Freshwater - One Axle
- K71-780-00: Pad Replacement Kit (DB 35) - Saltwater - One Axle
- K71-029-00: Vault Service Kit - 2.328" Outer Bore
- K71-033-00: Trailer Buddy SS Protector & Bra Kit - 2.328" Bore
- K71-037-00: Trailer Buddy Gold Oil - 2.328" Outer Bore
- K71-055-00: Bearing & Seal Replacement Kit - 2.328" Outer Bore
- K71-062-00: Spindle Hardware Kit - 5.2K Thru 7K Spindles

K08-440-05

Single Boxed Hub and Rotor: 6K 655,
Cupped and Studded, Zinc (DB35)



Compatible with:

- K71-773-01: Caliper Assy Kit - LH - Zinc
- K71-773-02: Caliper Assy Kit - RH - Zinc
- K71-776-01: Caliper Assy Kit - LH - Aluminum
- K71-776-02: Caliper Assy Kit - RH - Aluminum
- K71-779-00: Pad Replacement Kit (DB 35) - Freshwater - One Axle
- K71-780-00: Pad Replacement Kit (DB 35) - Saltwater - One Axle
- K71-028-00: Vault Service Kit - 6K 655 - 2.441" Outer Bore
- K71-032-00: Trailer Buddy SS Protector & Bra Kit - 2.441" Outer Bore
- K71-044-00: Bearing & Seal Replacement Kit - 2.441" Outer Bore
- K71-062-00: Spindle Hardware Kit - 5.2K Thru 7K Spindles

K08-442-05

Single Boxed Hub and Rotor: 4.2K 545,
Cupped and Studded, Zinc (DB35)



Compatible with:

- K71-773-01: Caliper Assy Kit - LH - Zinc
- K71-773-02: Caliper Assy Kit - RH - Zinc
- K71-776-01: Caliper Assy Kit - LH - Aluminum
- K71-776-02: Caliper Assy Kit - RH - Aluminum
- K71-779-00: Pad Replacement Kit (DB 35) - Freshwater - One Axle
- K71-780-00: Pad Replacement Kit (DB 35) - Saltwater - One Axle
- K71-029-00: Vault Service Kit - 2.328" Outer Bore
- K71-033-00: Trailer Buddy SS Protector & Bra Kit - 2.328" Bore
- K71-037-00: Trailer Buddy Gold Oil - 2.328" Outer Bore
- K71-058-00: Bearing & Seal Replacement Kit - 2.328" Outer Bore
- K71-063-00: Spindle Hardware Kit - 4.2K Spindles

K08-435-05

Single Boxed Hub and Rotor: 3.7K 545, Cupped and Studded, Zinc (DB35)



Compatible with:

- K71-773-01: Caliper Assy Kit - LH - Zinc
- K71-773-02: Caliper Assy Kit - RH - Zinc
- K71-776-01: Caliper Assy Kit - LH - Aluminum
- K71-776-02: Caliper Assy Kit - RH - Aluminum
- K71-779-00: Pad Replacement Kit (DB 35) - Freshwater - One Axle
- K71-780-00: Pad Replacement Kit (DB 35) - Saltwater - One Axle
- K71-030-00: Vault Service Kit - 1.980" Outer Bore
- K71-034-00: Trailer Buddy SS Protector & Bra Kit - 1.980" Outer Bore
- K71-036-00: Trailer Buddy Gold Oil - 1.980" Outer Bore
- K71-059-00: Bearing & Seal Replacement Kit - 1.980" Outer Bore
- K71-064-00: Spindle Hardware Kit - 3.2K & 3.7K Spindles

K08-450-03

Single Boxed Hub and Rotor: 5.2K 655, Cupped and Studded, (DB42) Black



Compatible with:

- K71-778-01: Caliper Assy Kit - LH - Old Style - Prior 2005
- K71-778-02: Caliper Assy Kit - RH - Old Style - Prior 2005
- K71-781-00: Pad Replacement Kit - Old Style - One Axle
- K71-033-00: Trailer Buddy SS Protector & Bra Kit - 2.328" Bore
- K71-055-00: Bearing & Seal Replacement Kit - 2.328" Outer Bore
- K71-062-00: Spindle Hardware Kit - 5.2K Thru 7K Spindles

K08-443-05

Single Boxed Hub and Rotor: 3.2K 545 Special 8", Cupped & Studded, Zinc (DB35)



Compatible with:

- K71-774-01: Caliper Assy Kit - LH - Special 8" Disc - Zinc
- K71-774-02: Caliper Assy Kit - RH - Special 8" Disc - Zinc
- K71-030-00: Vault Service Kit - 1.980" Outer Bore
- K71-034-00: Trailer Buddy SS Protector & Bra Kit - 1.980" Outer Bore
- K71-035-00: Trailer Buddy "Special" - 1.980" Outer Bore
- K71-059-00: Bearing & Seal Replacement Kit - 1.980" Outer Bore
- K71-064-00: Spindle Hardware Kit - 3.2K & 3.7K Spindles

K08-451-03

Single Boxed Hub and Rotor: 4.2K 545, Cupped and Studded, (DB 42) Black



Compatible with:

- K71-778-01: Caliper Assy Kit - LH - Old Style - Prior 2005
- K71-778-02: Caliper Assy Kit - RH - Old Style - Prior 2005
- K71-781-00: Caliper Pad Replacement Kit - Old Style - (For One Axle)
- K71-033-00: Trailer Buddy SS Protector & Bra Kit - 2.328" Bore
- K71-058-00: Bearing & Seal Replacement Kit - 2.328" Outer Bore
- K71-063-00: Spindle Hardware Kit - 4.2K Spindles

K08-452-03

Single Boxed Hub and Rotor: 3.7K 545,
Cupped and Studded, (DB 42) Black



Compatible with:

- K71-778-01: Caliper Assy Kit - LH - Old Style - Prior 2005
- K71-778-02: Caliper Assy Kit - RH - Old Style - Prior 2005
- K71-781-00: Caliper Pad Replacement Kit - Old Style - (For One Axle)
- K71-034-00: Trailer Buddy SS Protector & Bra Kit - 1.980" Outer Bore
- K71-035-00: Trailer Buddy "Special" - 1.980" Outer Bore
- K71-059-00: Bearing & Seal Replacement Kit - 1.980" Outer Bore
- K71-064-00: Spindle Hardware Kit - 3.2K & 3.7K Spindles

K08-444-05

Single Boxed Hub, Idler: 7K 865, Cupped
and Studded, Zinc



Compatible with:

- K71-027-00: Vault Service Kit - 2.717" Outer Bore
- K71-031-00: Trailer Buddy SS Protector & Bra Kit - 2.717" Outer Bore
- K71-043-00: Bearing & Seal Replacement Kit - 2.717" Outer Bore
- K71-062-00: Spindle Hardware Kit - 5.2K Thru 7K Spindles

K08-445-05

Single Boxed Hub, Idler: 6K 655, Cupped
and Studded, Zinc



Compatible with:

- K71-028-00: Vault Service Kit - 2.441" Outer Bore
- K71-032-00: Trailer Buddy SS Protector & Bra Kit - 2.441" Outer Bore
- K71-044-00: Bearing & Seal Replacement Kit - 2.441" Outer Bore
- K71-062-00: Spindle Hardware Kit - 5.2K Thru 7K Spindles

K08-446-05

Single Boxed Hub, Idler: 5.2K 655, Cupped and Studded, Zinc



Compatible with:

- K71-029-00: Vault Service Kit - 2.328" Outer Bore
- K71-033-00: Trailer Buddy SS Protector & Bra Kit - 2.328" Bore
- K71-037-00: Trailer Buddy Gold Oil - 2.328" Outer Bore
- K71-055-00: Bearing & Seal Replacement Kit - 2.328" Outer Bore
- K71-062-00: Spindle Hardware Kit - 5.2K Thru 7K Spindles

K08-436-05

Single Boxed Hub, Idler: 3.7K 545, Cupped and Studded, Zinc



Compatible with:

- K71-030-00: Vault Service Kit - 1.980" Outer Bore
- K71-034-00: Trailer Buddy SS Protector & Bra Kit - 1.980" Outer Bore
- K71-035-00: Trailer Buddy "Special" - 1.980" Outer Bore
- K71-036-00: Trailer Buddy Gold Oil - 1.980" Outer Bore
- K71-059-00: Bearing & Seal Replacement Kit - 1.980" Outer Bore
- K71-064-00: Spindle Hardware Kit - 3.2K & 3.7K Spindles

K08-447-05

Single Boxed Hub, Idler: 4.2K 545, Cupped and Studded, Zinc



Compatible with:

- K71-029-00: Vault Service Kit - 2.328" Outer Bore
- K71-033-00: Trailer Buddy SS Protector & Bra Kit - 2.328" Bore
- K71-037-00: Trailer Buddy Gold Oil - 2.328" Outer Bore
- K71-058-00: Bearing & Seal Replacement Kit - 2.328" Outer Bore
- K71-063-00: Spindle Hardware Kit - 4.2K Spindles

K08-448-06

Single Boxed Hub, Idler: 2.5K 545, Cupped and Studded, Painted Black



Compatible with:

- K71-030-00: Vault Service Kit - 1.980" Outer Bore
- K71-034-00: Trailer Buddy SS Protector & Bra Kit - 1.980" Outer Bore
- K71-035-00: Trailer Buddy "Special" - 1.980" Outer Bore
- K71-060-00: Bearing & Seal Replacement Kit - 1.980" Outer Bore
- K71-065-00: Spindle Hardware Kit - 2.5K Spindles

K08-448-10

Single Boxed Hub Kit, Idler: 2.1K 545,
Cupped and Studded, Painted Black



Compatible with:

- K71-034-00: Trailer Buddy SS Protector & Bra Kit -1.980" Outer Bore
- K71-035-00: Trailer Buddy "Special" - 1.980" Outer Bore
- K71-060-00: Bearing & Seal Replacement Kit - 1.980" Outer Bore
- K71-066-00: Spindle Hardware Kit - 2.1K & 2.3K Spindles

K99-060-00

A-60 Inner Member, Drum Boxed Kit

Qty	Description
1	A-60 Inner Member, Drum
1	Cap, Black Plastic
1	Consumer Lockout

K99-060-20

A-60 Inner Member, Disc w/ Solenoid Boxed Kit

Qty	Description
1	A-60 Inner Member, Tandem Disc w/ Solenoid
1	Cap, Black Plastic
1	Consumer Lockout

K99-075-00

A-75 Inner Member, Drum Boxed Kit

Qty	Description
1	A-75 Inner Member, Drum
1	Cap, Black Plastic
1	Consumer Lockout

K99-075-20

A-75 Inner Member, Disc w/ Solenoid Boxed Kit

Qty	Description
1	A-75 Inner Member, Tandem Disc w/ Solenoid
1	Cap, Black Plastic
1	Consumer Lockout

K99-184-00

XR-84 Inner Member, Drum Boxed Kit

Qty	Description
1	XR-84 Inner Member, Drum
1	Cap, Black Plastic
1	Consumer Lockout

K99-184-20

XR-84 Inner Member, Single/Tandem Disc w/ Solenoid Boxed Kit

Qty	Description
1	XR-84 Inner Member, Tandem Disc w/ Solenoid
1	Cap, Black Plastic
1	Consumer Lockout

K99-084-00

A-84 Inner Member, Drum Boxed Kit

Qty	Description
1	A-84 Inner Member, Drum
1	Cap, Black Plastic
1	Consumer Lockout

K99-084-20

A-84 Inner Member, Single/Tandem Disc w/ Solenoid Boxed Kit

Qty	Description
1	A-84 Inner Member, Tandem Disc w/ Solenoid
1	Cap, Black Plastic
1	Consumer Lockout

K99-060-04

A-60S: Drum, Zinc, Bolt On, Top Mount Boxed Kit

Qty	Description
1	A-60S: Drum, Zinc, Bolt On, Top Mount
1	Cap, Black Plastic
1	Consumer Lockout
3	Bolt
6	Washer, Flat
3	Nut, Lock

K99-075-04

A-75S: Drum, Zinc, Bolt On, Top Mount Boxed Kit

Qty	Description
1	A-75S: Drum, Zinc, Bolt On, Top Mount
1	Cap, Black Plastic
1	Consumer Lockout
3	Bolt
6	Washer, Flat
3	Nut, Lock

K99-184-04

XR-84S: Drum, Zinc, Bolt On, Top Mount Boxed Kit

Qty	Description
1	XR-84S: Drum, Zinc, Bolt On, Top Mount
1	Cap, Black Plastic
1	Consumer Lockout
3	Bolt
6	Washer, Flat
3	Nut, Lock

K99-060-24

A-60S: Tandem Disc, Zinc, Bolt On, Top Mount Boxed Kit

Qty	Description
1	A-60S: Tandem Disc, Zinc, Bolt On, Top Mount
1	Cap, Black Plastic
1	Consumer Lockout
3	Bolt
6	Washer, Flat
3	Nut, Lock

K99-075-24

A-75S: Tandem Disc, Zinc, Bolt On, Top Mount Boxed Kit

Qty	Description
1	A-75S: Tandem Disc, Zinc, Bolt On, Top Mount
1	Cap, Black Plastic
1	Consumer Lockout
3	Bolt
6	Washer, Flat
3	Nut, Lock

K99-184-24

XR-84S: Tandem Disc, Zinc, Bolt On, Top Mount Boxed Kit

Qty	Description
1	XR-84S: Tandem Disc, Zinc, Bolt On, Top Mount
1	Cap, Black Plastic
1	Consumer Lockout
3	Bolt
6	Washer, Flat
3	Nut, Lock

K99-084-04

A-84S: Drum, Zinc, Bolt On, Top Mount Boxed Kit

Qty	Description
1	A-84S: Drum, Zinc, Bolt On, Top Mount
1	Cap, Black Plastic
1	Consumer Lockout
3	Bolt
6	Washer, Flat
3	Nut, Lock

K99-084-24

A-84S: Tandem Disc, Zinc, Bolt On, Top Mount Boxed Kit

Qty	Description
1	A-84S: Tandem Disc, Zinc, Bolt On, Top Mount
1	Cap, Black Plastic
1	Consumer Lockout
3	Bolt
6	Washer, Flat
3	Nut, Lock



Hydraulic Drum Brakes

Dex # (UFP #)	Description
023-502-00 (32518L)	Hydraulic Brake, 10", LH, Silver, Aluminum W/C <i>(shown)</i>
023-503-00 (32518R)	Hydraulic Brake, 10", RH, Silver, Aluminum W/C
023-508-00 (32815L)	Hydraulic Brake, 12", LH, Silver, Aluminum W/C
023-509-00 (32815R)	Hydraulic Brake, 12", RH, Silver, Aluminum W/C

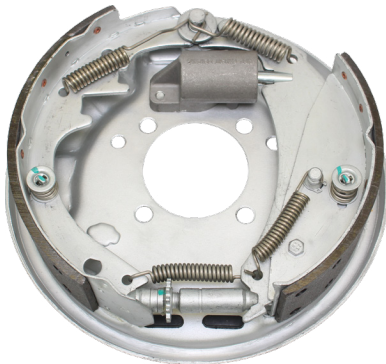

Hydraulic Drum Free Backing Brakes

Dex # (UFP #)	Description
023-498-00 (32681L)	Hydraulic Brake, 10", LH, Free backing, Silver, Aluminum W/C <i>(shown)</i>
023-499-00 (32681R)	Hydraulic Brake, 10", RH, Free backing, Silver, Aluminum W/C
023-504-00 (32682L)	Hydraulic Brake, 12", LH, Free backing, Silver, Aluminum W/C
023-505-00 (32682R)	Hydraulic Brake, 12", RH, Free backing, Silver, Aluminum W/C



Wheel Cylinder

Dex # (UFP #)	Description
054-123-01 (37202)	Wheel Cylinder, LH
054-123-02 (37203) <i>(shown)</i>	Wheel Cylinder, RH



Caliper

Dex # (UFP #)	Description
089-038-01 (36018L)	DB42 Caliper Only, Left <i>(shown above)</i>
089-038-02 (36018R)	DB42 Caliper Only, Right
K71-785-00 (36080)	DB42 Caliper Mounting Bracket with Clips <i>(shown below)</i>



Flex Hose

Dex # (UFP #)	Description
034-324-00 (32324)	Hose, 18" Flex, M/F Inverted Flair



Thermoplastic Brake Line

Dex # (UFP #)	Description
034-326-12 (37204-48)	Thermoplastic Brake Line, 48" <i>(shown at left top)</i>
034-326-31 (37204-96)	Thermoplastic Brake Line, 96" <i>(shown at left bottom)</i>
034-326-40 (37204-210)	Thermoplastic Brake Line, 210"
034-326-43 (37204-240)	Thermoplastic Brake Line, 240"

* Additional lengths available upon request



Miscellaneous Parts

No	Dex # (UFP #)	Description
1	034-323-00 (32275)	Fitting Banjo Single Inverted
2	007-307-00 (32307)	Bolt, Banjo
3	034-325-00 (32326)	Plug, 1/8" Pipe, SS
4	014-147-00 (32481)	Nylon Bushing
5	006-080-00 (32494)	Nut, Cone, Zinc, 1/2" - 20
6	013-162-00 (34050)	Rocker Arm, Assy, Triangle, Paint
7	005-169-00 (32230)	Washer, Copper
8	013-165-00 (32492)	Rocker Arm, Assy, Straight, Paint



Oil

Dex # (UFP #)	Purchase Qty	Description
088-014-00 (7032)	Multiples of 1	Oil, Trailer Buddy Gold, 1 Quart
088-013-00 (7036)	Multiples of 1	Hybrid Oil, Trailer Buddy, 14oz



Disc Brake Pads (fits DB42)

Dex # (UFP #)	Purchase Qty	Description
091-009-00 (33016)	1 set	Set of Pads, DB42 (1 inner and 1 outer)



Disc Brake Pads (fits DB35)

Dex # (UFP #)	Purchase Qty	Description
091-007-00 (33009)	Multiples of 50	Universal Brake Pad, Inner/Outer, DB35

Bulk Seals (packaged)

Dex # (UFP #)	Purchase Qty	Description
010-172-00 (32123)	Multiples of 10	Seal, 2.56 OD, 1.68 ID
010-180-00 (32372)	Multiples of 10	Seal, 2.33 OD, 1.68 ID
010-181-00 (32125)	Multiples of 15	Seal, 3.38 OD, 2.13 ID
010-182-00 (32369)	Multiples of 20	Seal, 1.98 OD, 1.25 ID
010-183-00 (32364)	Multiples of 20	Seal, 1.98 OD, 1.38 ID

CORROSION RESISTANCE

HUB/ROTOR & CALIPER OPTIONS

Zinc+ Hub/Rotor with Zinc Caliper <ul style="list-style-type: none"> ■ Zinc+ plated integral hub/rotor. ■ Zinc plated caliper with chrome plated piston. ■ Painted brake pad plate and zinc plated anchor yoke. 	
Zinc+ Hub/Rotor with Aluminum Caliper <ul style="list-style-type: none"> ■ Zinc+ plated integral hub/rotor. ■ Aluminum caliper with aluminum piston. ■ Dacromet® coated brake pad plate and anchor yoke. 	
Zinc+ Hub / Stainless Steel Rotor with Aluminum Caliper <ul style="list-style-type: none"> ■ Zinc+ plated hub with stainless steel rotor attached. ■ Aluminum caliper with aluminum piston. ■ Dacromet® coated brake pad plate and anchor yoke. 	
Zinc+ Hub / Stainless Steel Rotor with Stainless Steel Caliper <ul style="list-style-type: none"> ■ Zinc+ plated hub with stainless steel rotor attached. ■ Stainless steel caliper with stainless steel piston. ■ Stainless steel brake pad plate and a stainless steel anchor yoke. 	

Zinc = zinc plated

Zinc+ = zinc plated with top coat sealant that provides five times the corrosion protection when applied over zinc plating

Corrosion resistant components included in all above options

- Slider pins, pad guides, and anti-rattle springs are stainless steel in all options.
- Banjo bolts and bleeder screws are zinc plated on the zinc caliper option and stainless steel on the aluminum and stainless caliper options.



Additional Features

- No left hand or right hand calipers. (Fittings are shipped loose allowing the installer the ability to use caliper on either side. When mounting calipers, the bleeder screw position should always be on top to allow proper bleeding.)
- Ventilated rotors for temperature regulation to reduce brake pad deterioration, excessive wear and warping.
- Non-metallic, non-asbestos, organic pad materials to eliminate corrosion.
- Disc brake caliper to be used with 13" wheels and larger.
- Inlet/outlet port positions decrease amount of air in the system through a large range of torsion arm trailing angles.
- Braking forces are transferred to the yoke/anchor bracket and not the caliper slider pins.

WHEEL END & AXLE KITS

COMPLETE WHEEL END KITS

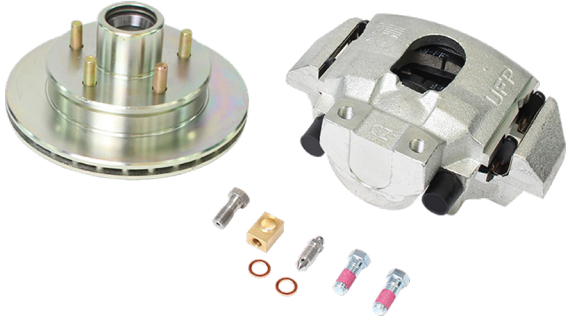
3,750 lb Zinc+ Hub/Rotor with Zinc Caliper

			
K71-077-00 (Shown)		K71-077-02	
ONE WHEEL END KIT		ONE AXLE KIT	
Qty	Description	Qty	Description
1	5 Bolt Zinc+ Hub/Rotor	2	5 Bolt Zinc+ Hub/Rotors
1	Zinc Caliper	2	Zinc Calipers
1	Banjo Fitting	2	Banjo Fittings
1	Banjo Bolt	2	Banjo Bolts
1	Bleeder Screw	2	Bleeder Screws
2	Copper Washers	4	Copper Washers
2	Caliper Mounting Bolts	4	Caliper Mounting Bolts

K71-077-05	
ONE COMPLETE WHEEL END KIT	
Qty	Description
1	K71-077-00 (3,750 lb Zinc+ Hub/Rotor with Zinc Caliper)
2	Seals (ID-1.68", ID-1.71")
1	Inner Bearing L68149
1	Outer Bearing L44649
1	SS Bearing Protector
1	Bra
5	Cone Nuts

3,750 lb Zinc+ Hub/Rotor with Aluminum Caliper

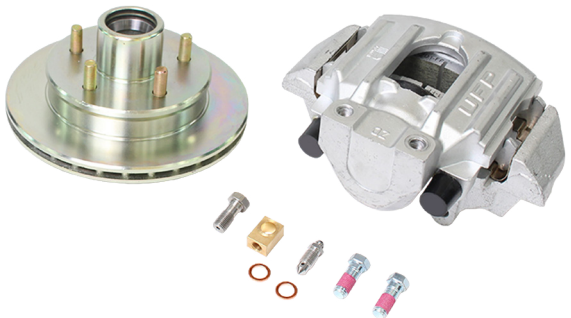
			
K71-078-00 (Shown)		K71-078-02	
ONE WHEEL END KIT		ONE AXLE KIT	
Qty	Description	Qty	Description
1	5 Bolt Zinc+ Hub/Rotor	2	5 Bolt Zinc+ Hub/Rotors
1	Aluminum Caliper	2	Aluminum Calipers
1	Banjo Fitting	2	Banjo Fittings
1	Banjo Bolt	2	Banjo Bolts
1	Bleeder Screw	2	Bleeder Screws
2	Copper Washers	4	Copper Washers
2	Caliper Mounting Bolts	4	Caliper Mounting Bolts

K71-078-05	
ONE COMPLETE WHEEL END KIT	
Qty	Description
1	K71-078-00 (3,750 lb Zinc+ Hub/Rotor with Aluminum Caliper)
2	Seals (ID-1.68", ID-1.71")
1	Inner Bearing L68149
1	Outer Bearing L44649
1	SS Bearing Protector
1	Bra
5	Cone Nuts

BOXED DISC BRAKES: INTEGRAL

WHEEL END & AXLE KITS

COMPLETE WHEEL END KITS

3,750 lb Zinc+ Hub/Stainless Steel Rotor with Aluminum Caliper

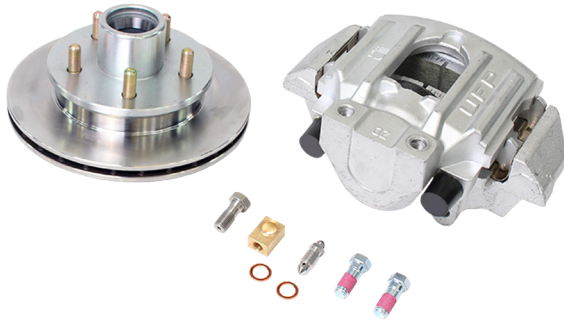

K71-079-00 (Shown)

K71-079-02

K71-079-05

ONE WHEEL END KIT

ONE AXLE KIT

ONE COMPLETE WHEEL END KIT

Qty	Description	Qty	Description	Qty	Description
1	5 Bolt Zinc+ Hub/SS Rotor	2	5 Bolt Zinc+ Hub/SS Rotors	1	K71-079-00 (3,750 lb Zinc+ Hub/SS Rotor with Aluminum Caliper)
1	Aluminum Caliper	2	Aluminum Calipers	2	Seals (ID-1.68", ID-1.71")
1	Banjo Fitting	2	Banjo Fittings	1	Inner Bearing L68149
1	Banjo Bolt	2	Banjo Bolts	1	Outer Bearing L44649
1	Bleeder Screw	2	Bleeder Screws	1	SS Bearing Protector
2	Copper Washers	4	Copper Washers	1	Bra
2	Caliper Mounting Bolts	4	Caliper Mounting Bolts	5	Cone Nuts

3,750 lb Zinc+ Hub/Stainless Steel Rotor with Stainless Steel Caliper

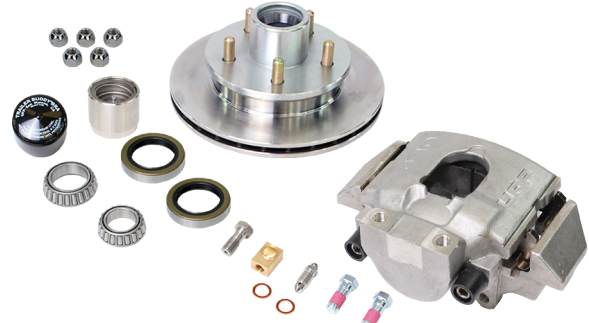
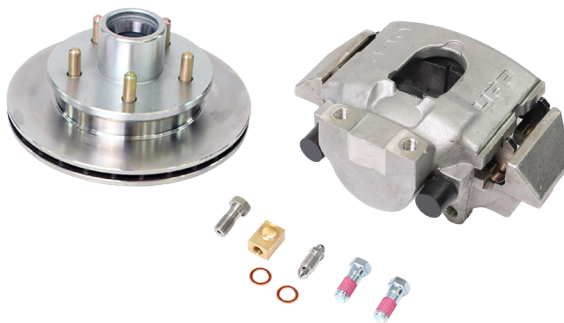

K71-088-00 (Shown)

K71-088-02

K71-088-05

ONE WHEEL END KIT

ONE AXLE KIT

ONE COMPLETE WHEEL END KIT

Qty	Description	Qty	Description	Qty	Description
1	5 Bolt Zinc+ Hub/SS Rotor	2	5 Bolt Zinc+ Hub/SS Rotors	1	K71-088-00 (3,750 lb Zinc+ Hub/SS Rotor with SS Steel Caliper)
1	Stainless Caliper	2	Stainless Calipers	2	Seals (ID-1.68", ID-1.71")
1	Banjo Fitting	2	Banjo Fittings	1	Inner Bearing L68149
1	Banjo Bolt	2	Banjo Bolts	1	Outer Bearing L44649
1	Bleeder Screw	2	Bleeder Screws	1	SS Bearing Protector
2	Copper Washers	4	Copper Washers	1	Bra
2	Caliper Mounting Bolts	4	Caliper Mounting Bolts	5	Cone Nuts

WHEEL END & AXLE KITS

COMPLETE WHEEL END KITS

6,000 lb Zinc+ Hub/Rotor with Zinc Caliper

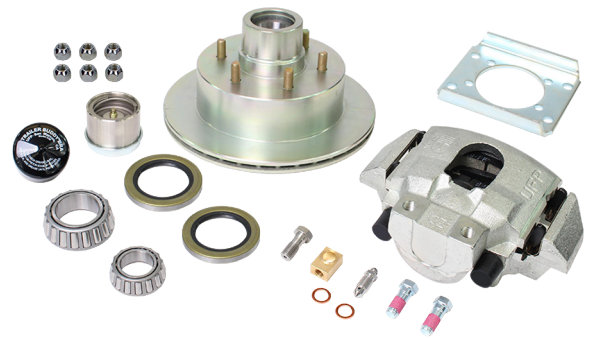
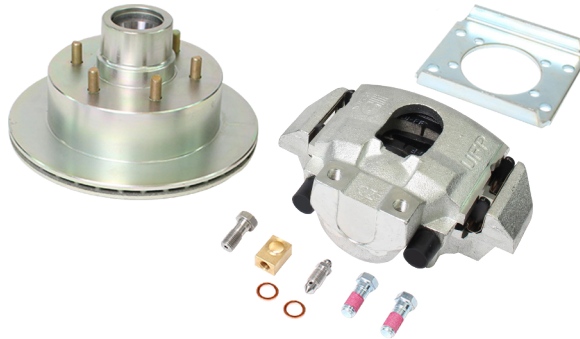

K71-089-00 (Shown)

K71-089-02

K71-089-05

ONE WHEEL END KIT

ONE AXLE KIT

ONE COMPLETE WHEEL END KIT

Qty	Description	Qty	Description	Qty	Description
1	6 Bolt Zinc+ Hub/Rotor	2	6 Bolt Zinc+ Hub/Rotors	1	K71-089-00 (6,000 lb Zinc+ Hub/Rotor with Zinc Caliper)
1	Zinc Caliper	2	Zinc Calipers	2	Seals (ID-2.13", ID-2.25")
1	Banjo Fitting	2	Banjo Fittings	1	Inner Bearing 25580
1	Banjo Bolt	2	Banjo Bolts	1	Outer Bearing 15123
1	Bleeder Screw	2	Bleeder Screws	1	SS Bearing Protector
2	Copper Washers	4	Copper Washers	1	Bra
2	Caliper Mounting Bolts	4	Caliper Mounting Bolts	6	Cone Nuts
1	Caliper Mounting Bracket	2	Caliper Mounting Brackets		

6,000 lb Zinc+ Hub/Rotor with Aluminum Caliper

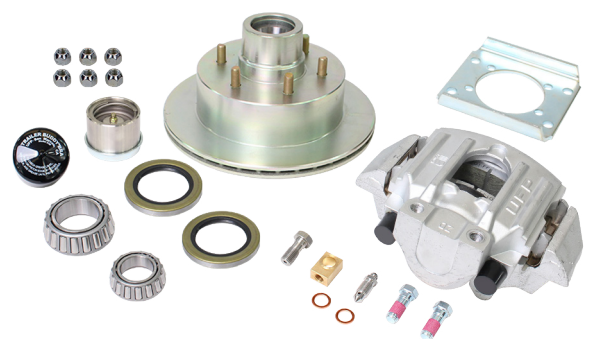
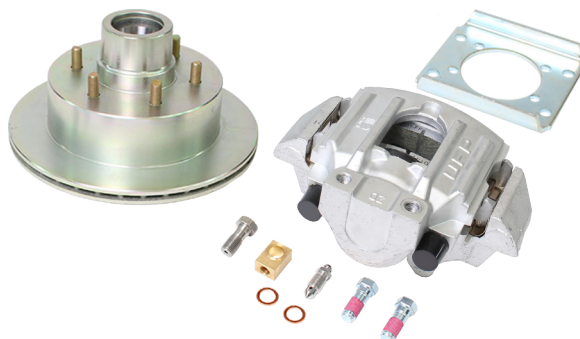

K71-090-00 (Shown)

K71-090-02

K71-090-05

ONE WHEEL END KIT

ONE AXLE KIT

ONE COMPLETE WHEEL END KIT

Qty	Description	Qty	Description	Qty	Description
1	6 Bolt Zinc+ Hub/Rotor	2	6 Bolt Zinc+ Hub/Rotors	1	K71-090-00 (6,000 lb Zinc+ Hub/Rotor with Aluminum Caliper)
1	Aluminum Caliper	2	Aluminum Calipers	2	Seals (ID-2.13", ID-2.25")
1	Banjo Fitting	2	Banjo Fittings	1	Inner Bearing 25580
1	Banjo Bolt	2	Banjo Bolts	1	Outer Bearing 15123
1	Bleeder Screw	2	Bleeder Screws	1	SS Bearing Protector
2	Copper Washers	4	Copper Washers	1	Bra
2	Caliper Mounting Bolts	4	Caliper Mounting Bolts	6	Cone Nuts
1	Caliper Mounting Bracket	2	Caliper Mounting Brackets		

WHEEL END & AXLE KITS

COMPLETE WHEEL END KITS

6,000 lb Zinc+ Hub/Stainless Rotor with Aluminum Caliper

K71-954-00 (Shown)		K71-954-02		K71-954-05	
ONE WHEEL END KIT		ONE AXLE KIT		ONE COMPLETE WHEEL END KIT	
Qty	Description	Qty	Description	Qty	Description
1	6 Bolt Zinc+ Hub/SS Rotor	2	6 Bolt Zinc+ Hub/SS Rotors	1	K71-773-00 (6,000 lb Zinc+ Hub/SS Rotor with Aluminum Caliper)
1	Aluminum Caliper	2	Aluminum Calipers	2	Seals (ID-2.13", ID-2.25")
1	Banjo Fitting	2	Banjo Fittings	1	Inner Bearing 25580
1	Banjo Bolt	2	Banjo Bolts	1	Outer Bearing 15123
1	Bleeder Screw	2	Bleeder Screws	1	SS Bearing Protector
2	Copper Washers	4	Copper Washers	1	Bra
2	Caliper Mounting Bolts	4	Caliper Mounting Bolts	6	Cone Nuts
1	Caliper Mounting Bracket	2	Caliper Mounting Brackets		

6,000 lb Zinc+ Hub/Stainless Steel Rotor with Stainless Steel Caliper

K71-786-00 (Shown)		K71-786-02		K71-786-05	
ONE WHEEL END KIT		ONE AXLE KIT		ONE COMPLETE WHEEL END KIT	
Qty	Description	Qty	Description	Qty	Description
1	6 Bolt Zinc+ Hub/SS Rotor	2	6 Bolt Zinc+ Hub/SS Rotors	1	K71-786-00 (6,000 lb Zinc+ Hub/Stainless Steel Rotor with SS Caliper)
1	SS Caliper	2	SS Calipers	2	Seals (ID-2.13", ID-2.25")
1	Banjo Fitting	2	Banjo Fittings	1	Inner Bearing 25580
1	Banjo Bolt	2	Banjo Bolts	1	Outer Bearing 15123
1	Bleeder Screw	2	Bleeder Screws	1	SS Bearing Protector
2	Copper Washers	4	Copper Washers	1	Bra
2	Caliper Mounting Bolts	4	Caliper Mounting Bolts	6	Cone Nuts
1	Caliper Mounting Bracket	2	Caliper Mounting Brackets		

WHEEL END & AXLE KITS

COMPLETE WHEEL END KITS

7,000 lb Zinc+ Hub/Rotor with Zinc Caliper

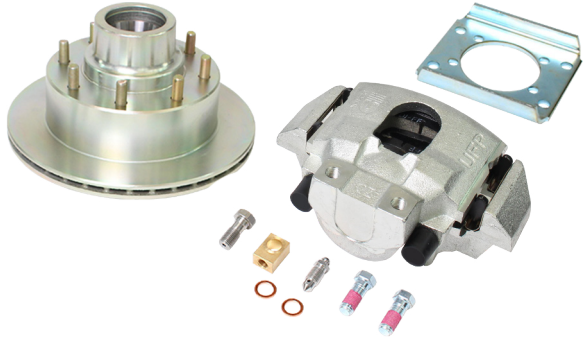
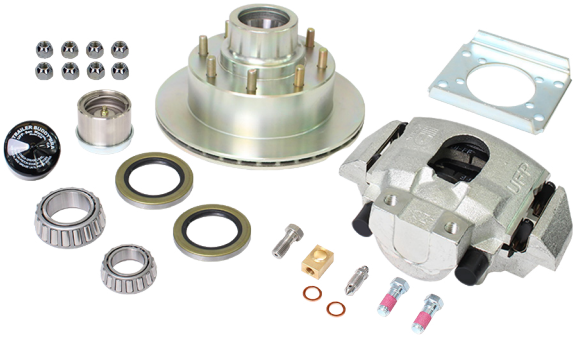
					
K71-824-00 (Shown)		K71-824-02		K71-824-05	
ONE WHEEL END KIT		ONE AXLE KIT		ONE COMPLETE WHEEL END KIT	
Qty	Description	Qty	Description	Qty	Description
1	8 Bolt Zinc+ Hub/Rotor	2	8 Bolt Zinc+ Hub/Rotors	1	K71-824-00 (7,000 lb Zinc+ Hub/Rotor with Zinc Caliper)
1	Zinc Caliper	2	Zinc Calipers	2	Seals (ID-2.13", ID-2.25")
1	Banjo Fitting	2	Banjo Fittings	1	Inner Bearing 25580
1	Banjo Bolt	2	Banjo Bolts	1	Outer Bearing 14125A
1	Bleeder Screw	2	Bleeder Screws	1	SS Bearing Protector
2	Copper Washers	4	Copper Washers	1	Bra
2	Caliper Mounting Bolts	4	Caliper Mounting Bolts	8	Cone Nuts
1	Caliper Mounting Bracket	2	Caliper Mounting Brackets		

7,000 lb Zinc+ Hub/Rotor with Aluminum Caliper

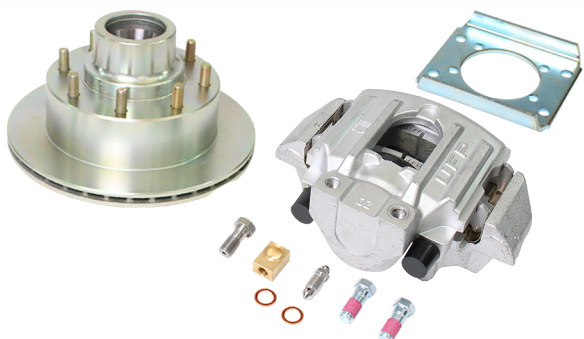
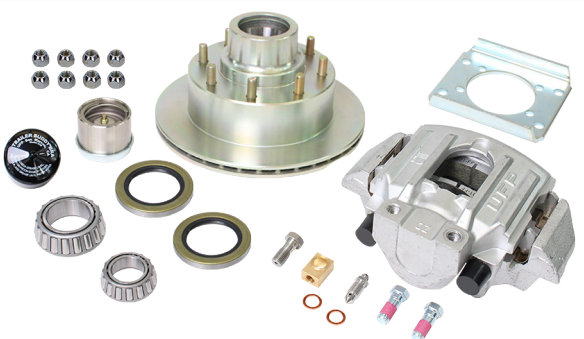
					
K71-806-00 (Shown)		K71-806-02		K71-806-05	
ONE WHEEL END KIT		ONE AXLE KIT		ONE COMPLETE WHEEL END KIT	
Qty	Description	Qty	Description	Qty	Description
1	8 Bolt Zinc+ Hub/Rotor	2	8 Bolt Zinc+ Hub/Rotors	1	K71-806-00 (7,000 lb Zinc+ Hub/Rotor with Aluminum Caliper)
1	Aluminum Caliper	2	Aluminum Calipers	2	Seals (ID-2.13", ID-2.25")
1	Banjo Fitting	2	Banjo Fittings	1	Inner Bearing 25580
1	Banjo Bolt	2	Banjo Bolts	1	Outer Bearing 14125A
1	Bleeder Screw	2	Bleeder Screws	1	SS Bearing Protector
2	Copper Washers	4	Copper Washers	1	Bra
2	Caliper Mounting Bolts	4	Caliper Mounting Bolts	8	Cone Nuts
1	Caliper Mounting Bracket	2	Caliper Mounting Brackets		

BOXED DISC BRAKES: INTEGRAL

WHEEL END & AXLE KITS

COMPLETE WHEEL END KITS

7,000 lb Zinc+ Hub/Stainless Steel Rotor with Aluminum Caliper

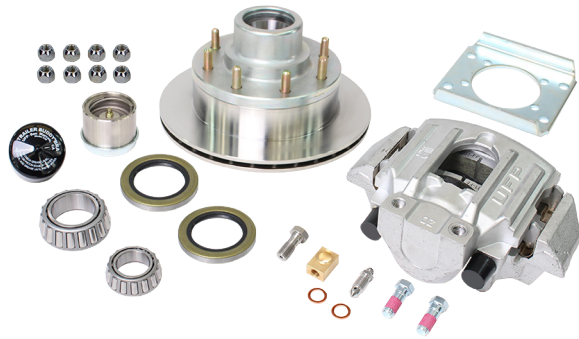
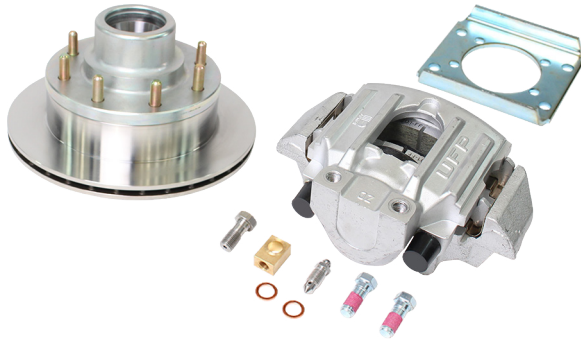

K71-807-00 (Shown)

K71-807-02

K71-807-05

ONE WHEEL END KIT

ONE AXLE KIT

ONE COMPLETE WHEEL END KIT

Qty	Description	Qty	Description	Qty	Description
1	8 Bolt Zinc+ Hub/SS Rotor	2	8 Bolt Zinc+ Hub/SS Rotors	1	K71-807-00 (7,000 lb Zinc+ Hub/Stainless SS with Aluminum Caliper)
1	Aluminum Caliper	2	Aluminum Calipers	2	Seals (ID-2.13", ID-2.25")
1	Banjo Fitting	2	Banjo Fittings	1	Inner Bearing 25580
1	Banjo Bolt	2	Banjo Bolts	1	Outer Bearing 14125A
1	Bleeder Screw	2	Bleeder Screws	1	SS Bearing Protector
2	Copper Washers	4	Copper Washers	1	Bra
2	Caliper Mounting Bolts	4	Caliper Mounting Bolts	8	Cone Nuts
1	Caliper Mounting Bracket	2	Caliper Mounting Brackets		

7,000 lb Zinc+ Hub/Stainless Steel Rotor with Stainless Steel Caliper

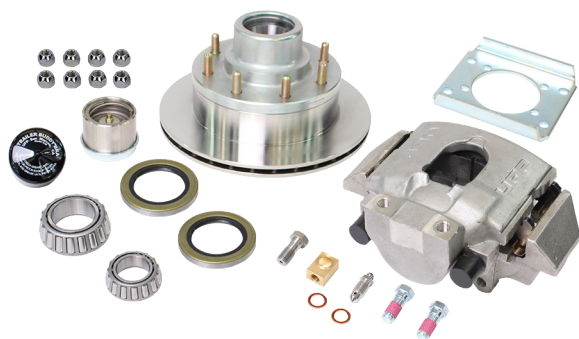
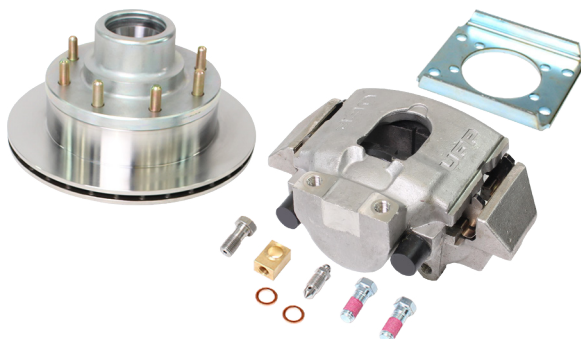

K71-808-00 (Shown)

K71-808-02

K71-808-05

ONE WHEEL END KIT

ONE AXLE KIT

ONE COMPLETE WHEEL END KIT

Qty	Description	Qty	Description	Qty	Description
1	8 Bolt Zinc+ Hub/SS Rotor	2	8 Bolt Zinc+ Hub/SS Rotors	1	K71-808-00 (7,000 lb Zinc+ Hub/Stainless Steel Rotor with SS Caliper)
1	SS Caliper	2	SS Calipers	1	Seals (ID-2.13", ID-2.25")
1	Banjo Fitting	2	Banjo Fittings	1	Inner Bearing 25580
1	Banjo Bolt	2	Banjo Bolts	1	Outer Bearing 14125A
1	Bleeder Screw	2	Bleeder Screws	1	SS Bearing Protector
2	Copper Washers	4	Copper Washers	1	Bra
2	Caliper Mounting Bolts	4	Caliper Mounting Bolts	8	Cone Nuts
1	Caliper Mounting Bracket	2	Caliper Mounting Brackets		

WHEEL END & AXLE KITS

COMPLETE WHEEL END KITS

8,000 lb Zinc+ Hub/Rotor with Aluminum Caliper

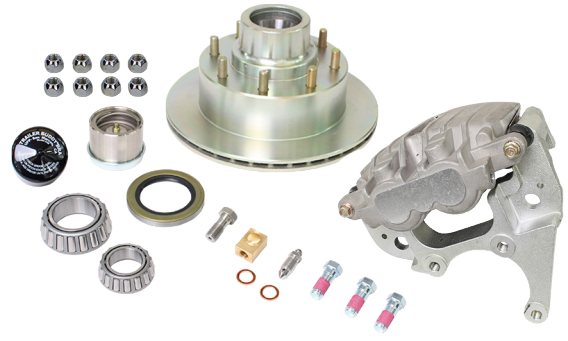
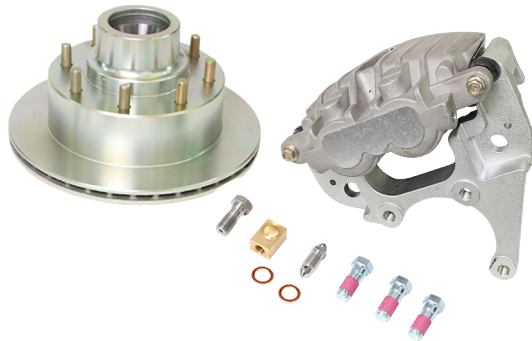

K71-820-00 (Shown)

K71-820-02

K71-820-05

ONE WHEEL END KIT

ONE AXLE KIT

ONE COMPLETE WHEEL END KIT

Qty	Description	Qty	Description	Qty	Description
1	8 Bolt Zinc+ Hub/Rotor	2	8 Bolt Zinc+ Hub/Rotors	1	K71-820-00 (8,000 lb Zinc+ Hub/Rotor with Aluminum Caliper)
1	Aluminum Caliper	2	Aluminum Calipers	1	Seal
1	Banjo Fitting	2	Banjo Fittings	1	Inner Bearing 25580
1	Banjo Bolt	2	Banjo Bolts	1	Outer Bearing 02475
1	Bleeder Screw	2	Bleeder Screws	1	SS Bearing Protector
2	Copper Washers	4	Copper Washers	1	Bra
3	Caliper Mounting Bolts	6	Caliper Mounting Bolts	8	Cone Nuts

Note: Mounting yoke on 8,000 lbs. caliper is specifically designed to mount on a Dexter Axle 8,000 lbs. brake flange.

BOXED DISC BRAKES: INTEGRAL

CORROSION RESISTANCE

ROTOR & CALIPER OPTIONS

<p>Zinc⁺ Rotor with Zinc Caliper</p> <ul style="list-style-type: none"> ■ Zinc+ plated rotor. ■ Zinc plated caliper with chrome plated piston. ■ Painted brake pad plate and zinc plated anchor yoke. 	
<p>Zinc⁺ Rotor with Aluminum Caliper</p> <ul style="list-style-type: none"> ■ Zinc+ plated rotor. ■ Aluminum caliper with aluminum piston. ■ Dacromet[®] coated brake pad plate and anchor yoke. 	
<p>Stainless Steel Rotor with Aluminum Caliper</p> <ul style="list-style-type: none"> ■ Stainless steel rotor. ■ Aluminum caliper with aluminum piston. ■ Dacromet[®] coated brake pad plate and anchor yoke. 	
<p>Stainless Steel Rotor with Stainless Steel Caliper</p> <ul style="list-style-type: none"> ■ Stainless steel rotor. ■ Stainless steel caliper with stainless steel piston. ■ Stainless steel brake pad plate and a Dacromet[®] anchor yoke. 	

Zinc = zinc plated

Zinc⁺ = zinc plated with top coat sealant that provides five times the corrosion protection when applied over zinc plating

Corrosion resistant components included in all above options

- Slider pins, pad guides, and anti-rattle springs are stainless steel in all options.
- Banjo bolts and bleeder screws are zinc plated on the zinc caliper option and stainless steel on the aluminum and stainless caliper options.

Note: All 3.7K Non-Integral Disc Brake Kits include a caliper mounting spacer bracket (see picture below). This spacer is **ONLY** necessary when the disc brake kit is used in conjunction with all Dexter Axle 008-248 idler hubs. The spacer is essential to accommodate for the unique internal bearing placement of the Dexter hub.

Additional Features

- No left hand or right hand calipers. (Fittings are shipped loose allowing the installer the ability to use caliper on either side. When mounting calipers, the bleeder screw position should always be on top to allow proper bleeding.)
- Ventilated rotors for temperature regulation to reduce brake pad deterioration, excessive wear and warping.
- Non-metallic, non-asbestos, organic pad materials to eliminate corrosion.
- Disc brake caliper to be used with 13" wheels and larger.
- Inlet/outlet port positions decrease amount of air in the system through a large range of torsion arm trailing angles.
- Braking forces are transferred to the yoke/anchor bracket and not the caliper slider pins.

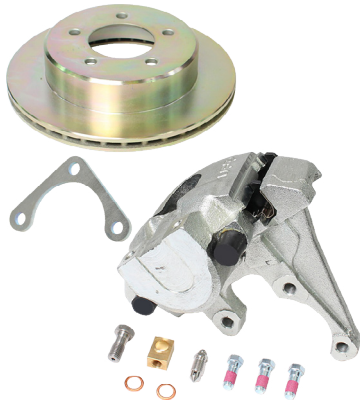

3,750 lb Zinc+ Rotor with Zinc Caliper

K71-809-00 (Shown)

K71-809-02

ONE WHEEL END KIT		ONE AXLE KIT	
Qty	Description	Qty	Description
1	5 Hole Zinc+ Rotor	2	5 Hole Zinc+ Rotors
1	Zinc Caliper	2	Zinc Calipers
1	Banjo Fitting	2	Banjo Fittings
1	Banjo Bolt	2	Banjo Bolts
1	Bleeder Screw	2	Bleeder Screws
2	Copper Washers	4	Copper Washers
3	Caliper Mounting Bolts	6	Caliper Mounting Bolts
1	Dexter Spacer Bracket	2	Dexter Spacer Brackets

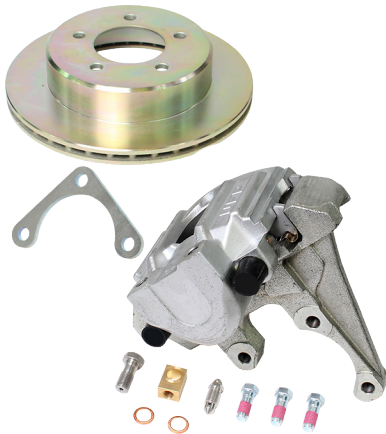

3,750 lb Zinc+ Rotor with Aluminum Caliper

K71-810-00 (Shown)

K71-810-02

ONE WHEEL END KIT		ONE AXLE KIT	
Qty	Description	Qty	Description
1	5 Hole Zinc+ Rotor	2	5 Hole Zinc+ Rotors
1	Aluminum Caliper	2	Aluminum Calipers
1	Banjo Fitting	2	Banjo Fittings
1	Banjo Bolt	2	Banjo Bolts
1	Bleeder Screw	2	Bleeder Screws
2	Copper Washers	4	Copper Washers
3	Caliper Mounting Bolts	6	Caliper Mounting Bolts
1	Dexter Spacer Bracket	2	Dexter Spacer Brackets

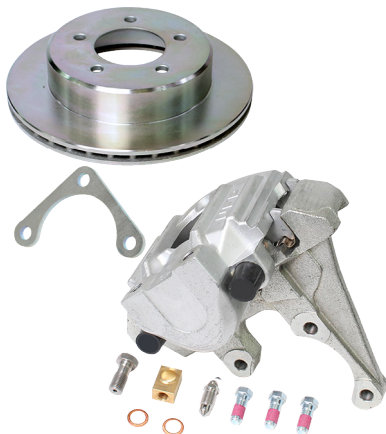

3,750 lb Stainless Steel Rotor with Aluminum Caliper

K71-811-00 (Shown)

K71-811-02

ONE WHEEL END KIT		ONE AXLE KIT	
Qty	Description	Qty	Description
1	5 Hole Stainless Steel Rotor	2	5 Hole Stainless Steel Rotors
1	Aluminum Caliper	2	Aluminum Calipers
1	Banjo Fitting	2	Banjo Fittings
1	Banjo Bolt	2	Banjo Bolts
1	Bleeder Screw	2	Bleeder Screws
2	Copper Washers	4	Copper Washers
3	Caliper Mounting Bolts	6	Caliper Mounting Bolts
1	Dexter Spacer Bracket	2	Dexter Spacer Brackets

BOXED DISC BRAKES: NON-INTEGRAL

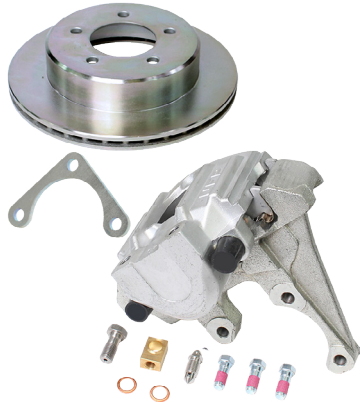

3,750 lb Stainless Steel Rotor with SS Caliper

K71-812-00 (Shown)

K71-812-02

ONE WHEEL END KIT		ONE AXLE KIT	
Qty	Description	Qty	Description
1	5 Hole Stainless Steel Rotor	2	5 Hole Stainless Steel Rotors
1	SS Caliper	2	SS Calipers
1	Banjo Fitting	2	Banjo Fittings
1	Banjo Bolt	2	Banjo Bolts
1	Bleeder Screw	2	Bleeder Screws
2	Copper Washers	4	Copper Washers
3	Caliper Mounting Bolts	6	Caliper Mounting Bolts
1	Dexter Spacer Bracket	2	Dexter Spacer Brackets



6,000 lb Zinc+ Rotor with Zinc Caliper

K71-813-00 (Shown)

K71-813-02

ONE WHEEL END KIT		ONE AXLE KIT	
Qty	Description	Qty	Description
1	6 Hole Zinc+ Rotor	2	6 Hole Zinc+ Rotors
1	Zinc Caliper	2	Zinc Calipers
1	Banjo Fitting	2	Banjo Fittings
1	Banjo Bolt	2	Banjo Bolts
1	Bleeder Screw	2	Bleeder Screws
2	Copper Washers	4	Copper Washers
2	Caliper Mounting Bolts	4	Caliper Mounting Bolts
1	Caliper Mounting Bracket	2	Caliper Mounting Brackets



6,000 lb Zinc+ Rotor with Aluminum Caliper

K71-814-00 (Shown)

K71-814-02

ONE WHEEL END KIT		ONE AXLE KIT	
Qty	Description	Qty	Description
1	6 Hole Zinc+ Rotor	2	6 Hole Zinc+ Rotors
1	Aluminum Caliper	2	Aluminum Calipers
1	Banjo Fitting	2	Banjo Fittings
1	Banjo Bolt	2	Banjo Bolts
1	Bleeder Screw	2	Bleeder Screws
2	Copper Washers	4	Copper Washers
2	Caliper Mounting Bolts	4	Caliper Mounting Bolts
1	Caliper Mounting Bracket	2	Caliper Mounting Bracket



6,000 lb Stainless Steel Rotor with Aluminum Caliper

K71-815-00 (Shown)

K71-815-02

ONE WHEEL END KIT		ONE AXLE KIT	
Qty	Description	Qty	Description
1	6 Hole Stainless Steel Rotor	2	6 Hole Stainless Steel Rotors
1	Aluminum Caliper	2	Aluminum Calipers
1	Banjo Fitting	2	Banjo Fittings
1	Banjo Bolt	2	Banjo Bolts
1	Bleeder Screw	2	Bleeder Screws
2	Copper Washers	4	Copper Washers
2	Caliper Mounting Bolts	4	Caliper Mounting Bolts
1	Dexter Spacer Bracket	2	Dexter Spacer Brackets



6,000 lb Stainless Steel Rotor with SS Caliper

K71-816-00 (Shown)

K71-816-02

ONE WHEEL END KIT		ONE AXLE KIT	
Qty	Description	Qty	Description
1	6 Hole Stainless Steel Rotor	2	6 Hole Stainless Steel Rotors
1	SS Caliper	2	SS Calipers
1	Banjo Fitting	2	Banjo Fittings
1	Banjo Bolt	2	Banjo Bolts
1	Bleeder Screw	2	Bleeder Screws
2	Copper Washers	4	Copper Washers
2	Caliper Mounting Bolts	4	Caliper Mounting Bolts
1	Dexter Spacer Bracket	2	Dexter Spacer Brackets

SPRUNG AXLE: 2500 LB.

SA-25 - 2500# STRAIGHT AXLE

Description
SA-25 - 2,500# Axle, 5 on 4.5" Hubs, 2" x 2" Square Tubing, Light Wall. 2,500# Rating Requires an 8" Overhang. Available in Idler Only

Spring Options						
Dexter	UFP	Type	Capacity (ea.)	Width	Length	Leaves
072-085-00	32466	Double Eye	1125	1.75	26	3
072-086-00	32467	Double Eye	1500	1.75	26	4
072-089-00	32477	Slipper	1200	1.75	25	3

Options and Accessories

Description
Lubrication Options
Lubed
Trailer Buddy® - Cap Style (1.980")
Galvanize

Axle Load Rating vs. Overhang (Inches per side)						
Model	6"	7"	8"	9"	10"	Cap. (lbs.)
SA-25	2,500	2,500	2,500	2,250	2,030	

SA-29 - SA-35 SERIES - STRAIGHT SPINDLE AXLES

Description
SA-29 - 2,900# Axle, 5 on 4.5" Hubs, 2" x 2" Square Tubing, Light Wall. 2,900# Rating Requires a 7" Overhang.
SA-35 - 3,500# Axle, 5 on 4.5" Hubs, 2" x 2" Square Tubing, Light Wall. 3,500# Rating Requires a 7" Overhang.

Spring Options					
Dexter	Type	Capacity (ea.)	Width	Length	Leaves
072-086-00	Double Eye	1500	1.75	26	4
072-087-00	Double Eye	1875	1.75	26	5
072-090-00	Slipper	1200	1.75	25	3
072-094-00	Slipper	1400	1.75	25	4

Options and Accessories

Description	Description
Axle Beam Options	Hub & Rotor Coating Options (Caliper Options Added Separately)
Raw - No Coating	E-Coat
Galvanized Axle Beam	Zinc+
V-Bend	Zinc+ Hub w/Stainless Steel Rotor
Lubrication Options	Caliper Options (Hub & Rotor Options Added Separately)
Lubed	Zinc
Trailer Buddy® - Cap Style (1.980")	Aluminum
Vault™ Hybrid Lubrication System™	Stainless Steel
Idler Hub Coating Options (All Hubs Are 5 on 4.50")	Parking Features (Zinc Caliper Only)
E-Coat	Drum Brake Options (Includes Brake Assembly and Hub & Drum)
Zinc+ Coating	Electric - Marine Grade
	Hydraulic Drum - Marine Grade
	Hydraulic Drum Free Backing - Marine Grade

Axle Load Rating vs. Overhang (Inches per side)					
Model	7"	8"	9"	10"	Cap. (lbs.)
SA-29	2,900	2,540	2,250	2,030	
SA-35	3,500	3,060	2,720	2,450	

DC-25 SERIES - DROP SPINDLE AXLES

Description
D-25 - 2,500# Axle, 5 on 4.5" Hubs, 2" x 2" Square Tubing, Light Wall. 2,500# Rating Requires an 8" Overhang.
Note: Drop axles available in 2 1/2, 3 1/2, 4 1/2, and 5 1/2 drops. Drop is measured from bottom of spring pad to center line of spindle.

Spring Options						
Dexter	UFP	Type	Capacity (ea.)	Width	Length	Leaves
072-085-00	32466	Double Eye	1125	1.75	26	3
072-086-00	32467	Double Eye	1500	1.75	26	4
072-089-00	32477	Slipper	1200	1.75	25	3

Options and Accessories

Description
Lubrication Options
Lubed
Trailer Buddy® - Cap Style (1.980")
Galvanize

Axle Load Rating vs. Overhang (Inches per side)						
Model	6"	7"	8"	9"	10"	Cap. (lbs.)
DC-23	2,300	2,300	2,300	2,250	2,030	
DC-25	2,500	2,500	2,500	2,250	2,030	

DC-29 - DC-35 SERIES - DROP SPINDLE AXLES

Description
DC-29 - 2,900# Axle, 5 on 4.5" Hubs, 2" x 2" Square Tubing, Light Wall. 2,900# Rating Requires a 7" Overhang.
DC-35 - 3,500# Axle, 5 on 4.5" Hubs, 2" x 2" Square Tubing, Light Wall. 3,500# Rating Requires a 7" Overhang.
Note: Drop axles available in 2 1/2, 3 1/2, 4 1/2, and 5 1/2 drops. Drop is measured from bottom of spring pad to center line of spindle.

Spring Options						
Dexter	UFP	Type	Capacity (ea.)	Width	Length	Leaves
072-086-00	32467	Double Eye	1500	1.75	26	4
072-087-00	32468	Double Eye	1875	1.75	26	5
072-090-00	32488	Slipper	1200	1.75	25	3
072-094-00	30001	Slipper	1400	1.75	25	4

Options and Accessories

Description	Description
Axle Beam Options	Hub & Rotor Coating Options (Caliper Options Added Separately)
Raw - No Coating	E-Coat
Galvanized Axle Beam	Zinc ⁺
V-Bend	Zinc ⁺ Hub w/Stainless Steel Rotor
Lubrication Options	Caliper Options (Hub & Rotor Options Added Separately)
Lubed	Zinc
Trailer Buddy® - Cap Style (1.980")	Aluminum
Vault™ Hybrid Lubrication System™	Stainless Steel
Idler Hub Coating Options (All Hubs Are 5 on 4.50")	Parking Features (Zinc Caliper Only)
E-Coat	Drum Brake Options (Includes Brake Assembly and Hub & Drum)
Zinc ⁺ Coating	Electric - Marine Grade
	Hydraulic Drum - Marine Grade
	Hydraulic Drum Free Backing - Marine Grade

Axle Load Rating vs. Overhang (Inches per side)					
Model	7"	8"	9"	10"	Cap. (lbs.)
DC-29	2,900	2,540	2,250	2,030	
DC-35	3,500	3,060	2,720	2,450	

DC-37 SERIES - DROP SPINDLE AXLES

Description
DC-37 - 3,700# Axle, 5 on 4.50" Hubs, 2" x 3" Rectangle Tubing, Light Wall. 3,700# Rating Requires a 7" Overhang.
Note: Drop axles available in 2 1/2, 3 1/2, 4 1/2, and 5 1/2 drops. Drop is measured from bottom of spring pad to center line of spindle.

Spring Option						
Dexter	UFP	Type	Capacity (ea.)	Width	Length	Leaves
072-087-00	32468	Double Eye	1875	1.75	26	5

Options and Accessories

Description	Description
Axle Beam Options	Hub & Rotor Coating Options (Caliper Options Added Separately)
Raw - No Coating	E-Coat
Galvanized Axle Beam	Zinc+
V-Bend	Zinc+ Hub w/Stainless Steel Rotor
Lubrication Options	Caliper Options (Hub & Rotor Options Added Separately)
Lubed	Zinc
Trailer Buddy® - Cap Style (1.980")	Aluminum
Vault™ Hybrid Lubrication System™	Stainless Steel
Idle Hub Coating Options (All Hubs Are 5 on 4.50")	Parking Features (Zinc Caliper Only)
E-Coat	Drum Brake Options (Includes Brake Assembly and Hub & Drum)
Zinc+ Coating	Electric - Marine Grade
	Hydraulic Drum - Marine Grade
	Hydraulic Drum Free Backing - Marine Grade

Axle Load Rating vs. Overhang (Inches per side)					
Model	7"	8"	9"	10"	Cap. (lbs.)
DC-37	3,750	3,750	3,750	3,625	

DC-42 SERIES - DROP SPINDLE AXLES

Description
DC-42 - 4,200# Axle, 5 on 4.50" Hubs, 2" x 3" Rectangle Tubing, Light Wall. 4,200# Rating Requires a 8" Overhang.
Note: Drop axles available in 2 1/2, 3 1/2, 4 1/2, and 5 1/2 drops. Drop is measured from bottom of spring pad to center line of spindle.

Spring Options						
Dexter	UFP	Type	Capacity (ea.)	Width	Length	Leaves
072-087-00	32468	Double Eye	1875	1.75	26	5
072-088-00	32469	Double Eye	2600	1.75	26	7

Options and Accessories

Description	Description
Axle Beam Options	Hub & Rotor Coating Options (Caliper Options Added Separately)
Raw - No Coating	E-Coat
Galvanized Axle Beam	Zinc+
V-Bend	Zinc+ Hub w/Stainless Steel Rotor
Lubrication Options	Caliper Options (Hub & Rotor Options Added Separately)
Lubed	Zinc
Trailer Buddy® - Cap Style (1.980")	Aluminum
Vault™ Hybrid Lubrication System™	Stainless Steel
Idler Hub Coating Options (All Hubs Are 5 on 4.50")	Parking Features (Zinc Caliper Only)
Zinc+ Coating	

Axle Load Rating vs. Overhang (Inches per side)					
Model	7"	8"	9"	10"	Cap. (lbs.)
DC-42	4,200	4,200	4,040	3,625	

DC-52 SERIES - DROP SPINDLE AXLES

Description
DC-52 - 5,200# Axle, 6 on 5.50" Hubs, 2" x 3" Rectangle Tubing, Heavy Wall. 5,200# Rating Requires a 8" Overhang.
Note: Drop axles available in 2 1/2, 3 1/2, 4 1/2, and 5 1/2 drops. Drop is measured from bottom of spring pad to center line of spindle.

Spring Option						
Dexter	UFP	Type	Capacity (ea.)	Width	Length	Leaves
072-088-00	32469	Double Eye	2600	1.75	26	7

Options and Accessories

Description	Description
Axle Beam Options	Hub & Rotor Coating Options (Caliper Options Added Separately)
Raw - No Coating	E-Coat
Galvanized Axle Beam	Zinc+
V-Bend	Zinc+ Hub w/Stainless Steel Rotor
Lubrication Options	Caliper Options (Hub & Rotor Options Added Separately)
Lubed	Zinc
Trailer Buddy® - Cap Style (1.980")	Aluminum
Vault™ Hybrid Lubrication System™	Stainless Steel
Idler Hub Coating Options (All Hubs Are 6 on 5.50")	Parking Features (Zinc Caliper Only)
E-Coat	Drum Brake Options (Includes Brake Assembly and Hub & Drum)
Zinc+ Coating	Electric - Marine Grade
	Hydraulic Drum - Marine Grade
	Hydraulic Drum Free Backing - Marine Grade

Axle Load Rating vs. Overhang (Inches per side)				
Model	8"	9"	10"	Cap. (lbs.)
DC-52	5,200	5,190	4,700	

DC-60 SERIES - DROP SPINDLE AXLES

Description
DC-60 - 6,000# Axle, 6 on 5.50" Hubs, 2" x 3" Rectangle Tubing, Heavy Wall. 6,000# Rating Requires a 8" Overhang.
Note: Drop axles available in 2 1/2, 3 1/2, 4 1/2, and 5 1/2 drops. Drop is measured from bottom of spring pad to center line of spindle.

Options and Accessories

Description	Description
Axle Beam Options	Hub & Rotor Coating Options (Caliper Options Added Separately)
Raw - No Coating	E-Coat
Galvanized Axle Beam	Zinc+
V-Bend	Zinc+ Hub w/Stainless Steel Rotor
Lubrication Options	Caliper Options (Hub & Rotor Options Added Separately)
Lubed	Zinc
Trailer Buddy® - Cap Style (1.980")	Aluminum
Vault™ Hybrid Lubrication System™	Stainless Steel
Idler Hub Coating Options (All Hubs Are 6 on 5.50")	Parking Features (Zinc Caliper Only)
E-Coat	Drum Brake Options (Includes Brake Assembly and Hub & Drum)
Zinc+ Coating	Electric - Marine Grade
	Hydraulic Drum - Marine Grade
	Hydraulic Drum Free Backing - Marine Grade

TORSION AXLE: 3700 LB.

3700# TORSION AXLES

Description
3.7K Torsion Axle - Raw Trailing Arms, Idler, Flanged, 5 on 4.50", E-Coat Hub, Flat Mounting Brackets, Lubed Spindle

Options and Accessories

Description	Description
Bracket Options	Idler Hub Coating Options (All Hubs Are 5 on 4.50")
Flat Bracket	E-Coat
Flat Bracket, Reverse	Zinc ⁺ Coating
Short Bracket, 1.82"	Hub & Rotor Coating Options (Caliper Options Added Separately)
Short Bracket, Reversed, 1.82"	E-Coat
Tall Bracket, 4.32"	Zinc ⁺
I-Beam Bracket	Zinc ⁺ Hub w/Stainless Steel Rotor
Side Mount Kit (Flat & Short Bracket Only)	Caliper Options (Hub & Rotor Options Added Separately)
Axle Beam Options	Zinc
Raw - No Coating	Aluminum
Galvanized	Stainless Steel
V-Bend	Parking Features (Zinc Caliper Only)
Trailing Arm Option (Specify Start Angle or Ship Trailing Arms Loose)	Drum Brake Options (Includes Brake Assembly and Hub & Drum)
Raw - No Coating	Electric - Marine Grade
Zinc ⁺ Coating	Hydraulic Drum - Marine Grade
Lubrication Options	Hydraulic Drum Free Backing - Marine Grade
Lubed	
Trailer Buddy [®] - Cap Style (1.980")	
Vault [™] Hybrid Lubrication System [™]	

Overhang Dimensions - Per Side	Brake Type	Min. Standard	Min Reversed
Difference Between Hub Face & Outside Mounting Brackets	Drum Brake	7.000"	6.180
Note: Minimum is based on manufacturing tolerances only. Some tire and wheel combinations may create interference	Drum Brake	7.000"	6.180

4200# TORSION AXLES

Description
4.2K Torsion Axle - Raw Trailing Arms, Idler, Flanged, 5 on 4.50", E-Coat Hub, Flat Mounting Brackets, Lubed Spindle

Options and Accessories

Description	Description
Bracket Options	Idler Hub Coating Options (All Hubs Are 5 on 4.50")
Flat Bracket	E-Coat
Flat Bracket, Reverse	Zinc ⁺ Coating
Short Bracket, 1.82"	Hub & Rotor Coating Options (Caliper Options Added Separately)
Short Bracket, Reversed, 1.82"	E-Coat
Tall Bracket, 4.32"	Zinc ⁺
I-Beam Bracket	Zinc ⁺ Hub w/Stainless Steel Rotor
Side Mount Kit (Flat & Short Bracket Only)	Caliper Options (Hub & Rotor Options Added Separately)
Axle Beam Options	Zinc
Raw - No Coating	Aluminum
Galvanized	Stainless Steel
V-Bend	Parking Features (Zinc Caliper Only)
Trailing Arm Option (Specify Start Angle or Ship Trailing Arms Loose)	
Raw - No Coating	
Zinc ⁺ Coating	
Lubrication Options	
Lubed	
Trailer Buddy [®] - Cap Style (2.328")	
Vault [™] Hybrid Lubrication System [™]	

Overhang Dimensions - Per Side	Brake Type	Min. Standard	Min Reversed
Difference Between Hub Face & Outside Mounting Brackets	Drum Brake	7.000"	6.180
Note: Minimum is based on manufacturing tolerances only. Some tire and wheel combinations may create interference	Drum Brake	7.000"	6.180

5200# TORSION AXLES

Description
5.2K Torsion Axle - Raw Trailing Arms, Idler, Flanged, 6 on 5.50", E-Coat Hub, Flat Mounting Brackets, Lubed Spindle

Options and Accessories

Description	Description
Bracket Options	Idler Hub Coating Options (All Hubs Are 6 on 5.50")
Flat Bracket	E-Coat
Flat Bracket, Reverse	Zinc ⁺ Coating
Short Bracket, 1.82"	Hub & Rotor Coating Options (Caliper Options Added Separately)
Short Bracket, Reversed, 1.82"	E-Coat
Tall Bracket, 4.32"	Zinc ⁺
I-Beam Bracket	Zinc ⁺ Hub w/Stainless Steel Rotor
Side Mount Kit (Flat & Short Bracket Only)	Caliper Options (Hub & Rotor Options Added Separately)
Axle Beam Options	Zinc
Raw - No Coating	Aluminum
Galvanized	Stainless Steel
V-Bend	Parking Features (Zinc Caliper Only)
Trailing Arm Option (Specify Start Angle or Ship Trailing Arms Loose)	Drum Brake Options (Includes Brake Assembly and Hub & Drum)
Raw - No Coating	Electric - Marine Grade
Zinc ⁺ Coating	Hydraulic Drum - Marine Grade
Lubrication Options	Hydraulic Drum Free Backing - Marine Grade
Lubed	
Trailer Buddy® - Cap Style (2.328")	
Vault™ Hybrid Lubrication System™	

Overhang Dimensions - Per Side	Brake Type	Min. Standard	Min Reversed
Difference Between Hub Face & Outside Mounting Brackets	Drum Brake	9.000"	7.688
Note: Minimum is based on manufacturing tolerances only. Some tire and wheel combinations may create interference	Drum Brake	9.000"	7.688

6000# TORSION AXLES

Description
6K Torsion Axle - Raw Trailing Arms, Idler, Flanged, 6 on 5.50", E-Coat Hub, Flat Mounting Brackets, Lubed Spindle

Options and Accessories

Description	Description
Bracket Options	Idler Hub Coating Options (All Hubs Are 6 on 5.50")
Flat Bracket	E-Coat
Flat Bracket, Reverse	Zinc+ Coating
Short Bracket, 1.82"	Hub & Rotor Coating Options (Caliper Options Added Separately)
Short Bracket, Reversed, 1.82"	E-Coat
Tall Bracket, 4.32"	Zinc+
I-Beam Bracket	Zinc+ Hub w/Stainless Steel Rotor
Side Mount Kit (Flat & Short Bracket Only)	Caliper Options (Hub & Rotor Options Added Separately)
Axle Beam Options	Zinc
Raw - No Coating	Aluminum
Galvanized	Stainless Steel
V-Bend	Parking Features (Zinc Caliper Only)
Trailing Arm Option (Specify Start Angle or Ship Trailing Arms Loose)	Drum Brake Options (Includes Brake Assembly and Hub & Drum)
Raw - No Coating	Electric - Marine Grade
Zinc+ Coating	Hydraulic Drum - Marine Grade
Lubrication Options	Hydraulic Drum Free Backing - Marine Grade
Lubed	
Trailer Buddy® - Cap Style (2.441")	
Vault™ Hybrid Lubrication System™	

Overhang Dimensions - Per Side	Brake Type	Min. Standard	Min Reversed
Difference Between Hub Face & Outside Mounting Brackets	Drum Brake	9.000"	7.688
Note: Minimum is based on manufacturing tolerances only. Some tire and wheel combinations may create interference	Drum Brake	9.000"	7.688

TORSION AXLE: 7000 LB.

7000# TORSION AXLES

Description
7K Torsion Axle - Raw Trailing Arms, Idler, Flanged, 8 on 6.50", E-Coat Hub, Flat Mounting Brackets, Lubed Spindle

Options and Accessories

Description	Description
Bracket Options	Idler Hub Coating Options (All Hubs Are 6 on 5.50")
Flat Bracket	E-Coat
Flat Bracket, Reverse	Zinc+ Coating
Short Bracket, 1.82"	Hub & Rotor Coating Options (Caliper Options Added Separately)
Short Bracket, Reversed, 1.82"	E-Coat
Tall Bracket, 4.32"	Zinc+
I-Beam Bracket	Zinc+ Hub w/Stainless Steel Rotor
Side Mount Kit (Flat & Short Bracket Only)	Caliper Options (Hub & Rotor Options Added Separately)
Axle Beam Options	Zinc
Raw - No Coating	Aluminum
Galvanized	Stainless Steel
V-Bend	Parking Features (Zinc Caliper Only)
Trailing Arm Option (Specify Start Angle or Ship Trailing Arms Loose)	Drum Brake Options (Includes Brake Assembly and Hub & Drum)
Raw - No Coating	Electric - Marine Grade
Zinc+ Coating	Hydraulic Drum - Marine Grade
Lubrication Options	Hydraulic Drum Free Backing - Marine Grade
Lubed	
Trailer Buddy® - Cap Style (2.717")	
Vault™ Hybrid Lubrication System™	

Overhang Dimensions - Per Side	Brake Type	Min. Standard	Min Reversed
Difference Between Hub Face & Outside Mounting Brackets	Drum Brake	9.000"	7.688
Note: Minimum is based on manufacturing tolerances only. Some tire and wheel combinations may create interference	Drum Brake	9.000"	7.688

GEARED FOR INNOVATION

Since 1960 Dexter has built a strong reputation as a trusted industry leader from our headquarters in Elkhart, Indiana. UFP has been a leading innovator and provider of trailer axles and brake system components to the recreation boating trailer market since 1963. Combined, Dexter and UFP provide innovative products and services to the RV, military, cargo, horse, utility, manufactured housing, and marine industries. Over 50 years later, the same principles still drive us: superior quality, continuous improvement, and unparalleled customer service.

Dexter - Headquarters

2900 Industrial Parkway East ■ Elkhart, Indiana 46516

Phone: 574-295-7888 ■ Fax: 574-295-8666

www.dexteraxle.com

Dexter - Plt 12

301 West Pearl Street
Fremont, Indiana 46737
Phone: 260-495-5100
Fax: 260-495-1701

Dexter - Plt 13

500 South 7th Street
Albion, Indiana 46701
Phone: 260-636-2195
Fax: 260-636-3030

Dexter - Plt 15

500 Southeast 27th Street
El Reno, Oklahoma 73036
Phone: 405-262-6700
Fax: 405-262-9089

Dexter - Plt 21

199 Perimeter Road
Monticello, Georgia 31064
Phone: 706-468-6495
Fax: 706-468-2966

Ventline - Plt 39

902 South Division Street
Bristol, Indiana 46507
Phone: 574-848-4491
Fax: 574-848-4825
www.ventline.com

Dexter Door - Plt 39

902 South Division Street
Bristol, Indiana 46507
Phone: 574-848-4491
Fax: 574-848-4825
www.dexterdoor.com

Dexter - Plt 61

21611 Protecta Drive
Elkhart, Indiana 46516
Phone: 574-294-6651
Fax: 574-295-6626

Dexter - Plt 62

301 North Kennedy Street
Shawnee, Oklahoma 74801
Phone: 405-273-9315
Fax: 405-273-1054

UFP - Plt 24

135 Sunshine Lane
San Marcos, California 92069
Phone: 760-744-1610
Fax: 760-744-1616
www.dexteraxle.com/ufp

UFP - Plt 25

1041 Baxter Lane
Winchester, Tennessee 37398
Phone: 931-967-5101
Fax: 931-967-1828
www.dexteraxle.com/ufp

